



MADE IN EU



AH



AA



AS AE AU AR



AC

AC CATALOG

WWW.AQUAFILTER.COM

CARTRIDGES



AC



AC
CARTRIDGES

AC CARTRIDGES

ACS - SEDIMENT CARTRIDGES 1

Cartridges are characterized by excellent sediment absorption of sand, silt, rust and suspended solids from potable water. In addition, these filter cartridges effectively protect expensive home appliances and residential plumbing systems.

ACC - CARBON CARTRIDGES 5

Filters feature coconut shell, granular activated carbon and are designed to reduce unwanted taste, odor, chlorine, and volatile organic carbon compounds (VOC's). Cartridges produce great-tasting and healthier drinking water.

ACR - RESIN CARTRIDGES 9

Cartridges with strongly acidic ion-exchange resin which reduces calcium and magnesium ion content in water (often called „hardness minerals“). Large amounts of these ions in water are responsible for the formation of scale deposits, higher detergent consumption and stains on glassware. In extreme cases large amounts of calcium and magnesium can lead to glass etching.

ACM - MINERALIZING CARTRIDGES 11

Originally designed as a post-filtration, mineralization and pH adjustment cartridge. The media will alkalize and remineralize water, raising its pH. They reduce acidity in the body and will produce natural calcium & magnesium ions that can be absorbed in the human body. These essential minerals are vital to our organs.

ACA - SPECIAL TYPE OF CARTRIDGES 13



Sets of Cartridges / RO Membranes / Special Type / Empty Casings



ACS-1 MELT-BLOWN POLYPROPYLENE CARTRIDGES



The construction of this pure polypropylene, surfactant-free depth filter ensures low pressure drops, with exceptional dirt holding capabilities. ACS-1 series uses no resin binders, lubricants, antistatic or release agents or other chemical additives. The one-step manufacturing process continuously extrudes and thermally bonds pure polypropylene microfibrils into a complex filter matrix. Cartridges are characterized by excellent sediment absorption of sand, silt, rust and suspended solids from potable water.

| CATALOG NUMBER | DESCRIPTION | CONNECTION | SIZE |
|---|--|------------|-----------------|
|  | AIPRO In-line 5 micron sediment filter cartridge - 1/4" | NPT | 2" x 10" |
|  | AIPRO-QC In-line 5 micron sediment filter cartridge - 1/4" | QF | 2" x 10" |
|  | AIPRO-CL In-line 5 micron sediment filter cartridge - 1/4" (transparent) | NPT | 2" x 11" |
|  | AIPRO-1M-AQ In-line 5 micron sediment cartridge - 1/4" | NPT | 2 1/2" x 12" |
|  | AIPRO-20M-AQ In-line 5 micron sediment cartridge - 1/4" | NPT | 2 1/2" x 12" |
|  | AIPRO-5M38-AQ In-line 5 micron sediment cartridge - 3/8" | NPT | 2 1/2" x 12" |
|  | AIPRO-5M38-QC In-line 5 micron sediment cartridge - 3/8" | QF | 2 1/2" x 12" |
|  | AIPRO-20M-QM In-line 5 micron sediment cartridge - 1/4" | I | 2 1/2" x 12" |
|  | AIPRO-5M-CL-QC In-line 5 micron sediment filter cartridge - 3/8" (transparent) | QF | 2 1/2" x 12" |
|  | AIPRO-1M-CL In-line 5 micron sediment filter cartridge - 1/4" (transparent) | NPT | 2 1/2" x 12" |
|  | AIPRO-1M-CL-AB In-line 5 micron sediment bacteriostatic filter cartridge - 1/4" (transparent) | NPT | 2 1/2" x 12" |
|  | AIPRO-1M-TW Twist type 5 micron sediment cartridge | BN1 | 2 1/2" x 12" |
|  | VO-82 Twist type 5 micron sediment cartridge | BN2 | 2 1/2" x 12" |
|  | AIPRO-1M-TW2 Twist type 5 micron sediment cartridge | BN3 | 2 1/2" x 12" |
|  | U-82 In-line 5 micron sediment cartridge - 3/8" | U | 2 1/2" x 12" |
|  | FCPS5-SL Candle 5 micron sediment cartridge 2 O-rings | SL | 2" x 10" |
|  | FCPS5-AB-SL Candle 5 micron bacteriostatic sediment cartridge 2 O-rings | SL | 2" x 10" |
|  | FCPS5-CT Candle 5 micron sediment cartridge with thread | SL | 2" x 10" |
|  | FCHOT2 Melt-blown polypropylene filter cartridge for hot water up to 93°C | DOE | 2 1/2" x 9 7/8" |



BN3



BN2



BN1



SL



U



I



QF



NPT

SEDIMENT CARTRIDGES

ICONS APPENDIX ON THE LAST PAGE

ACS-1 MELT-BLOWN POLYPROPYLENE CARTRIDGES



| CATALOG NUMBER | DESCRIPTION | CONNECTION | SIZE |
|----------------|---|------------|-----------------|
| FCPS1-5 | Melt-blown polypropylene filter cartridge 1 micron | DOE | 2 1/2" x 4 7/8" |
| FCPS5-5 | Melt-blown polypropylene filter cartridge 5 micron | DOE | 2 1/2" x 4 7/8" |
| FCPS20-5 | Melt-blown polypropylene filter cartridge 20 micron | DOE | 2 1/2" x 4 7/8" |
| FCPS50-5 | Melt-blown polypropylene filter cartridge 50 micron | DOE | 2 1/2" x 4 7/8" |
| FCPS1 | Melt-blown polypropylene filter cartridge 1 micron | DOE | 2 1/2" x 9 7/8" |
| FCPS5 | Melt-blown polypropylene filter cartridge 5 micron | DOE | 2 1/2" x 9 7/8" |
| FCPS10 | Melt-blown polypropylene filter cartridge 10 micron | DOE | 2 1/2" x 9 7/8" |
| FCPS20 | Melt-blown polypropylene filter cartridge 20 micron | DOE | 2 1/2" x 9 7/8" |
| FCPS50 | Melt-blown polypropylene filter cartridge 50 micron | DOE | 2 1/2" x 9 7/8" |
| FCPS1-L | Melt-blown polypropylene filter cartridge 1 micron | DOE | 2 1/2" x 20" |
| FCPS5-L | Melt-blown polypropylene filter cartridge 5 micron | DOE | 2 1/2" x 20" |
| FCPS20-L | Melt-blown polypropylene filter cartridge 20 micron | DOE | 2 1/2" x 20" |
| FCPS50-L | Melt-blown polypropylene filter cartridge 50 micron | DOE | 2 1/2" x 20" |
| FCPS5-30 | Melt-blown polypropylene filter cartridge 5 micron | DOE | 2 1/2" x 30" |
| FCPS20-30 | Melt-blown polypropylene filter cartridge 20 micron | DOE | 2 1/2" x 30" |
| FCPS5-40 | Melt-blown polypropylene filter cartridge 5 micron | DOE | 2 1/2" x 40" |
| FCPS20-40 | Melt-blown polypropylene filter cartridge 20 micron | DOE | 2 1/2" x 40" |
| FCPS1M10B | Melt-blown polypropylene filter cartridge 1 micron | DOE | 4 1/2" x 9 7/8" |
| FCPS1M10B | Melt-blown polypropylene filter cartridge 1 micron | DOE | 4 1/2" x 9 7/8" |
| FCPS5M10B | Melt-blown polypropylene filter cartridge 5 micron | DOE | 4 1/2" x 9 7/8" |
| FCPS20M10B | Melt-blown polypropylene filter cartridge 20 micron | DOE | 4 1/2" x 9 7/8" |
| FCPS50M10B | Melt-blown polypropylene filter cartridge 50 micron | DOE | 4 1/2" x 9 7/8" |
| FCPS1M20B | Melt-blown polypropylene filter cartridge 1 micron | DOE | 4 1/2" x 20" |
| FCPS5M20B | Melt-blown polypropylene filter cartridge 5 micron | DOE | 4 1/2" x 20" |
| FCPS20M20B | Melt-blown polypropylene filter cartridge 20 micron | DOE | 4 1/2" x 20" |
| FCPS50M20B | Melt-blown polypropylene filter cartridge 50 micron | DOE | 4 1/2" x 20" |
| FCPS5-AB | Melt-blown antimicrobial/antibacterial polypropylene filter cartridge 5 micron | DOE | 2 1/2" x 9 7/8" |
| FCPS20-AB | Melt-blown antimicrobial/antibacterial polypropylene filter cartridge 20 micron | DOE | 2 1/2" x 9 7/8" |
| FCPS5-L-AB | Melt-blown antimicrobial/antibacterial polypropylene filter cartridge 5 micron | DOE | 2 1/2" x 20" |
| FCPS20-L-AB | Melt-blown antimicrobial/antibacterial polypropylene filter cartridge 20 micron | DOE | 2 1/2" x 20" |
| FCHOT2 | Melt-blown polypropylene filter cartridge for hot water up to 93°C | DOE | 2 1/2" x 9 7/8" |

ACS-2 POLYPROPYLENE YARN SEDIMENT CARTRIDGES



Aquafilter ACS-2 series cartridges are made of FDA approved polypropylene string wound yarn on a polypropylene core which strengthens the cartridge.

It has a broad chemical compatibility, good temperature resistance and low cost. ACS-2 series cartridges are primarily used as the first stage of filtration.

Cartridges are characterized by excellent sediment absorption of sand, silt, rust and suspended solids from potable water.

| CATALOG NUMBER | DESCRIPTION | CONNECTION | SIZE |
|----------------|---|------------|-----------------|
| FCHOT1 | Yarn sediment cartridge for hot water applications up to 93°C | DOE | 2 1/2" x 9 7/8" |



SEDIMENT CARTRIDGES

ICONS APPENDIX ON THE LAST PAGE

ACS-2 POLYPROPYLENE YARN SEDIMENT CARTRIDGES



CATALOG NUMBER DESCRIPTION CONNECTION SIZE

| | | | |
|-------------------|------------------------------------|-----|-----------------|
| FCPP5-5 | Yarn sediment cartridge 5 micron | DOE | 2 1/2" x 4 7/8" |
| FCPP20-5 | Yarn sediment cartridge 20 micron | DOE | 2 1/2" x 4 7/8" |
| FCPP1 | Yarn sediment cartridge 1 micron | DOE | 2 1/2" x 9 7/8" |
| FCPP5 | Yarn sediment cartridge 5 micron | DOE | 2 1/2" x 9 7/8" |
| FCPP10 | Yarn sediment cartridge 10 micron | DOE | 2 1/2" x 9 7/8" |
| FCPP20 | Yarn sediment cartridge 20 micron | DOE | 2 1/2" x 9 7/8" |
| FCPP50 | Yarn sediment cartridge 50 micron | DOE | 2 1/2" x 9 7/8" |
| FCPP100 | Yarn sediment cartridge 100 micron | DOE | 2 1/2" x 9 7/8" |
| FCPP1-L | Yarn sediment cartridge 1 micron | DOE | 2 1/2" x 20" |
| FCPP5-L | Yarn sediment cartridge 5 micron | DOE | 2 1/2" x 20" |
| FCPP10-L | Yarn sediment cartridge 10 micron | DOE | 2 1/2" x 20" |
| FCPP20-L | Yarn sediment cartridge 20 micron | DOE | 2 1/2" x 20" |
| FCPP50-L | Yarn sediment cartridge 50 micron | DOE | 2 1/2" x 20" |
| FCPP100-L | Yarn sediment cartridge 100 micron | DOE | 2 1/2" x 20" |
| FCPP5-30 | Yarn sediment cartridge 5 micron | DOE | 2 1/2" x 30" |
| FCPP20-30 | Yarn sediment cartridge 20 micron | DOE | 2 1/2" x 30" |
| FCPP5-40 | Yarn sediment cartridge 5 micron | DOE | 2 1/2" x 40" |
| FCPP20-40 | Yarn sediment cartridge 20 micron | DOE | 2 1/2" x 40" |
| FCPP5M10B | Yarn sediment cartridge 5 micron | DOE | 4 1/2" x 9 7/8" |
| FCPP20M10B | Yarn sediment cartridge 20 micron | DOE | 4 1/2" x 9 7/8" |
| FCPP5M20B | Yarn sediment cartridge 5 micron | DOE | 4 1/2" x 20" |
| FCPP20M20B | Yarn sediment cartridge 20 micron | DOE | 4 1/2" x 20" |

| | | | |
|----------------------|---|-----|-----------------|
| FCPP5-AB | Yarn antimicrobial/antibacterial polypropylene filter cartridge 5 micron | DOE | 2 1/2" x 9 7/8" |
| FCPP20-AB | Yarn antimicrobial/antibacterial polypropylene filter cartridge 20 micron | DOE | 2 1/2" x 9 7/8" |
| FCPP5-L-AB | Yarn antimicrobial/antibacterial polypropylene filter cartridge 5 micron | DOE | 2 1/2" x 20" |
| FCPP20-L-AB | Yarn antimicrobial/antibacterial polypropylene filter cartridge 20 micron | DOE | 2 1/2" x 20" |
| FCPP5M10B-AB | Yarn antimicrobial/antibacterial polypropylene filter cartridge 5 micron | DOE | 4 1/2" x 9 7/8" |
| FCPP20M10B-AB | Yarn antimicrobial/antibacterial polypropylene filter cartridge 20 micron | DOE | 4 1/2" x 9 7/8" |
| FCPP5M20B-AB | Yarn antimicrobial/antibacterial polypropylene filter cartridge 5 micron | DOE | 4 1/2" x 20" |
| FCPP20M20B-AB | Yarn antimicrobial/antibacterial polypropylene filter cartridge 20 micron | DOE | 4 1/2" x 20" |

ACS-3 PLEATED SEDIMENT CARTRIDGES



Multi-use washable sediment filter cartridge, manufactured from durable polyester fabric. In order to provide increased surface area and longer life, ACS-3 series cartridges are pleated around a polypropylene core. The core gives the cartridges additional strength. The end caps are immersed in a vinyl plastisol which fuses these components together acting as both an endcap and a gasket.

Cartridges are characterized by excellent sediment absorption of sand, silt, rust and suspended solids from potable water.

CATALOG NUMBER DESCRIPTION CONNECTION SIZE



| | | | |
|--------------------|---|-----|-----------------|
| FCCEL5 | Multi-use polyester fabric pleated sediment cartridge 5 micron | DOE | 2 1/2" x 9 7/8" |
| FCCEL10 | Multi-use polyester fabric pleated sediment cartridge 10 micron | DOE | 2 1/2" x 9 7/8" |
| FCCEL20 | Multi-use polyester fabric pleated sediment cartridge 20 micron | DOE | 2 1/2" x 9 7/8" |
| FCCEL5-L | Multi-use polyester fabric pleated sediment cartridge 5 micron | DOE | 2 1/2" x 20" |
| FCCEL20-L | Multi-use polyester fabric pleated sediment cartridge 20 micron | DOE | 2 1/2" x 20" |
| FCCEL5M10B | Multi-use polyester fabric pleated sediment cartridge 5 micron | DOE | 4 1/2" x 9 7/8" |
| FCCEL20M10B | Multi-use polyester fabric pleated sediment cartridge 20 micron | DOE | 4 1/2" x 9 7/8" |
| FCCEL5M20B | Multi-use polyester fabric pleated sediment cartridge 5 micron | DOE | 4 1/2" x 20" |
| FCCEL20M20B | Multi-use polyester fabric pleated sediment cartridge 20 micron | DOE | 4 1/2" x 20" |





SEDIMENT CARTRIDGES

ICONS APPENDIX ON THE LAST PAGE

ACS-4 NYLON NET SEDIMENT CARTRIDGES



ACS-4 multi-use sediment 10" type filter cartridge, made of polypropylene and nylon mesh, (50,100 and 150 micron). Nylon net filter cartridge is designed and manufactured using both PP and Nylon net, mainly used for removing particles like: rust, sediment, particulate matter, suspended matter and asbestos, etc.

| CATALOG NUMBER | DESCRIPTION | CONNECTION | SIZE |
|---|--|------------|-----------------|
|  FCPNN50M | Multi-use nylon net sediment cartridge 50 micron for cold water | SOE | 2 1/2" x 9 7/8" |
| FCPNN100M | Multi-use nylon net sediment cartridge 100 micron for cold water | SOE | 2 1/2" x 9 7/8" |
| FCPNN150M | Multi-use nylon net sediment cartridge 150 micron for cold water | SOE | 2 1/2" x 9 7/8" |
|  FCPHH50M | Multi-use nylon net sediment cartridge 50 micron for hot water | SOE | 2 1/2" x 9 7/8" |
| FCPHH100M | Multi-use nylon net sediment cartridge 100 micron for hot water | SOE | 2 1/2" x 9 7/8" |
| FCPHH150M | Multi-use nylon net sediment cartridge 150 micron for hot water | SOE | 2 1/2" x 9 7/8" |

ACS-7 ULTRAFILTRATION CARTRIDGES



Water ultrafiltration (UF) is a filtration process that uses standard home water pressure to push water through its semi-permeable membrane. Ultrafiltration (UF) removes viruses, bacteria, as well as suspended particles from your drinking water. Particles and materials of high molecular weight are unable to pass through the 0.01-micron UF membrane so that only fresh water and dissolved minerals get through. The UF membrane also has a chemical resistance to oxidants and chlorine.

Ultrafiltration (UF) uses a porous membrane to remove bacteria and viruses while retaining minerals. A UF system is a waste-free alternative to reverse osmosis, leads to quicker and more efficient delivery of clean water. Moreover hollow fiber UF membranes leave beneficial minerals intact.











ACS-7 membranes are designed for cold potable water filtration.

Benefits of Ultrafiltration

An ultrafiltration water system keeps good minerals in your water without producing waste water. Ultrafiltration treatment runs at low water pressure, does not require a separate water holding tank, does not alter the pH of your water, and does not require electricity. The UF membrane is stable at a wide range pH levels. Historically, ultrafiltration has been used in large municipal water treatment plants and hospitals; however, thanks to technological advances you can now install a powerful under sink water filtration system in your home.

MEMBRANE FILTRATION STAGES

Since the filtration flow in our UF hollow fiber path is outside-to-inside, the contaminants from the feed will accumulate on the outside of the fibers, much like a cartridge filter that is familiar to all water purification. The purified water will flow through the center of the hollow fiber to be collected at the top of each hollow fiber tube. The TLCHF/27,45 filtration flow are inside-out.

| CATALOG NUMBER | DESCRIPTION | CONNECTION | SIZE |
|--|---|------------|-----------------|
|  TLCHF-2T | In-line ultrafiltration membrane 0.01 micron cartridge - 1/4" (transparent) | NPT | 2" x 11" |
|  TLCHF-FP | In-line ultrafiltration membrane 0.01 micron cartridge - 1/4" | NPT | 2 1/2" x 12" |
|  TLCHF-TW | Twist type ultrafiltration membrane 0.01 micron cartridge | BN1 | 2 1/2" x 12" |
|  VO-91 | Twist type ultrafiltration membrane 0.01 micron cartridge | BN2 | 2 1/2" x 12" |
|  TLCHF-TW2 | Twist type ultrafiltration membrane 0.01 micron cartridge | BN3 | 2 1/2" x 12" |
|  U-91 | In-line ultrafiltration membrane 0.01 micron cartridge - 3/8" | U | 2 1/2" x 12" |
|  TLCHF-SL | Candle ultrafiltration membrane 0.01 micron cartridge 2 O-rings | SL | 2" x 10" |
|  TLCHF | Ultrafiltration membrane 0.01 micron insert for 2 1/2" type empty cartridge | SL - PART | 2 1/2" x 10" |
|  TLCHF-MD | Single open end nylon net sediment with ultrafiltration membrane 0.01 micron | SOE | 2 1/2" x 9 7/8" |
|  TLCHF-27 | Ultrafiltration membrane 0.2 micron built in pvc housing length 27cm for poe systems, high flow | IN-OUT | POE |
|  TLCHF-45 | Ultrafiltration membrane 0.2 micron built in pvc housing length 45cm for poe systems, high flow | IN-OUT | POE |



CARBON CARTRIDGES

ICONS APPENDIX ON THE LAST PAGE

ACC-1 GAC CARTRIDGES



ACC-1 carbon filter cartridge uses mix blend of activated carbons to filter particles helps reduce unwanted taste, odors, dirt, chlorine and other contaminants from your water supply like VOCs from water supply systems.

Installing an up flow non-backwashing carbon filter is an easy, cost-effective way to remove chlorine taste and odor from city or well water. Up flow filters are simple to install and do not need electricity or drain connections to function. These water filters force water through the carbon media from underneath.



| CATALOG NUMBER | DESCRIPTION | CONNECTION | SIZE |
|----------------|--|------------|-----------------|
| FCCB5 | Granulated activated carbon cartridge | DOE | 2 1/2" x 4 7/8" |
| FCCB | Granulated activated carbon cartridge | DOE | 2 1/2" x 9 7/8" |
| FCCB-L | Granulated activated carbon cartridge | DOE | 2 1/2" x 20" |
| FCCB10BB | Granulated activated carbon cartridge | DOE | 4 1/2" x 9 7/8" |
| FCCB20BB | Granulated activated carbon cartridge | DOE | 4 1/2" x 20" |
| FCCA5 | Granulated activated carbon cartridge mix blend multimedia | DOE | 2 1/2" x 4 7/8" |
| FCCA | Granulated activated carbon cartridge mix blend multimedia | DOE | 2 1/2" x 9 7/8" |
| FCCA-L | Granulated activated carbon cartridge mix blend multimedia | DOE | 2 1/2" x 20" |
| FCCA10BB | Granulated activated carbon cartridge mix blend multimedia | DOE | 4 1/2" x 9 7/8" |
| FCCA20BB | Granulated activated carbon cartridge mix blend multimedia | DOE | 4 1/2" x 20" |
| FCCA-STO | Two stage filtration sediment / GAC | DOE | 2 1/2" x 9 7/8" |

ACC-2 ACTIVATED CARBON CARTRIDGES



Protect your home, health, and appliances by filtering your water. The ACC-2 Aquafilter Granular Activated Carbon Filter removes major contaminants from your water supply and provides clean water for drinking, showering, cooking, and other home uses. The GAC removes major water contaminants like Chlorine, Total Organic Carbon (TOC), Pharmaceuticals, Turbidity, Volatile Organic Chemicals (VOC), Herbicides, Industrial Solvents, Insecticides, Pesticides, and Chemicals causing bad tastes, odors, and more.

The UDF type filter is vacuum sealed and complete with a polypropylene shell, a thermal bonded cap, and an industrial sealed silicon ring to make sure its durable and reliable. Filter your water with high quality coconut carbon for maximum chemical absorption. Choose the filter that lasts longer to give you the best value in filtration.

| CATALOG NUMBER | DESCRIPTION | CONNECTION | SIZE |
|----------------|-------------|------------|------|
|----------------|-------------|------------|------|



| | | | |
|--------------|---|-----|--------------|
| AICRO5-AQ | In-line GAC coconut shell activated carbon cartridge - 1/4" | NPT | 2" x 6" |
| AICRO | In-line GAC coconut shell activated carbon cartridge - 1/4" | NPT | 2" x 10" |
| AICRO-QC | In-line GAC coconut shell activated carbon cartridge - 1/4" | QF | 2" x 10" |
| AICRO-AB | In-line GAC coconut shell carbon with bacteriostatic agent - 1/4" (transparent) | NPT | 2" x 11" |
| AICRO-L-AQ | In-line GAC coconut shell activated carbon cartridge - 1/4" | NPT | 2 1/2" x 12" |
| AICRO-L38-AQ | In-line GAC coconut shell activated carbon cartridge - 3/8" | NPT | 2 1/2" x 12" |
| AICRO-L-QC | In-line GAC coconut shell activated carbon cartridge - 1/4" | QF | 2 1/2" x 12" |
| AICRO-L38-QC | In-line GAC coconut shell activated carbon cartridge - 3/8" | QF | 2 1/2" x 12" |
| AICRO-3-QM | In-line GAC coconut shell activated carbon cartridge - 1/4" | I | 2 1/2" x 12" |
| VO-83 | Twist type GAC coconut shell activated carbon cartridge | BN2 | 2 1/2" x 12" |
| AICRO-TW2 | Twist type GAC coconut shell activated carbon cartridge | BN3 | 2 1/2" x 12" |
| U-83 | In-line GAC coconut shell activated carbon cartridge - 3/8" | U | 2 1/2" x 12" |
| FCCBHD-SL | Candle GAC coconut shell activated carbon cartridge 2 O-rings | SL | 2" x 10" |



BN3



BN2



BN1



SL



U



I



QF



NPT

CARBON CARTRIDGES

ICONS APPENDIX ON THE LAST PAGE

ACC-2 ACTIVATED CARBON CARTRIDGES



CATALOG NUMBER DESCRIPTION CONNECTION SIZE

| | | | |
|-------------------|---|-----|-----------------|
| FCCBHD5 | UDF type GAC coconut shell activated carbon cartridge | DOE | 2 1/2" x 4 7/8" |
| FCCBHD | UDF type GAC coconut shell activated carbon cartridge | DOE | 2 1/2" x 9 7/8" |
| FCCBHD-L | UDF type GAC coconut shell activated carbon cartridge | DOE | 2 1/2" x 20" |
| FCCBHD10BB | UDF type GAC coconut shell activated carbon cartridge | DOE | 4 1/2" x 9 7/8" |
| FCCBHD20BB | UDF type GAC coconut shell activated carbon cartridge | DOE | 4 1/2" x 20" |
| FCCBHD-STO | UDF type two stage filtration sediment / GAC coconut shell activated carbon cartridge | DOE | 2 1/2" x 4 7/8" |

ACC-3 GAC ACTIVATED CARBON CARTRIDGES / KDF



ACC-3 Aquafilter coconut shell granular activated carbon (GAC) is used in combination with KDF media to significantly extend the life of filter cartridges. KDF media is a redox media that removes chlorine and reduces heavy metals with bacteriostatic properties in addition the filter has the ability to remove water-soluble cations via the oxidation-reduction process resulting in a cost-effective alternative to chemical treatment.

KDF aids in the removal of chlorine when treating municipal waters and extends the carbon's life.

About Carbon / KDF

Activated carbon has remarkable cleaning and absorptive properties, which makes it an effective way to purify water. Chemicals and contaminants in the water are bonded at a molecular level to the carbon, effectively removing them from the water.

The UDF type filters are vacuum sealed and complete with a polypropylene shell, a thermal bonded cap, and an industrial sealed silicon ring to make sure its durable and reliable. Filter your water with high quality coconut carbon for maximum chemical absorption. Choose the filter that lasts longer to give you the best value in filtration.

ACC-3 cartridges are designed such that where water flows from bottom to top ensures a long contact time, allowing for maximum adsorption and treatment.

KDF utilizing redox reactions, kills or inhibits bacteria growth, converts chlorine to chlorides and removes iron, hydrogen sulfide and heavy metals (lead, arsenic, etc.). Used in combination with activated carbon, KDF can significantly extend the life of filter cartridges. Non-woven polypropylene creates a barrier that prevents filtration media from being washed out.

- >Protect your water - removes chlorine, volatile organic chemicals (VOC), herbicides, bad taste, odor, cloudiness, reduces heavy metals and have bacteriostatic properties
- >High standard filtration media - verified by independent laboratory testing.
- >Best filtration - efficiently arranged carbon granules create full coverage filtration which means your filter lasts longer
- >Universal standard size - 5-micron granular activated carbon (GAC) filter, fits all standard filter housings
- >Made to last - airtight vacuum sealed packaging prevents spoiling of your filter

CATALOG NUMBER DESCRIPTION CONNECTION SIZE



| | | | |
|--------------------|--|-----|--------------|
| AICRO-L4-AQ | In-line GAC coconut shell activated carbon cartridge with KDF 1/4" | NPT | 2 1/2" x 12" |
| AICRO-4-QM | In-line GAC coconut shell activated carbon cartridge with KDF 1/4" | I | 2 1/2" x 12" |
| VO-90 | Twist type GAC coconut shell activated carbon cartridge with KDF and polyphosphate | BN2 | 2 1/2" x 12" |
| U-90 | In-line GAC coconut shell activated carbon cartridge with KDF and polyphosphate 3/8" | U | 2 1/2" x 12" |
| FCCBKDF-SL | Candle GAC coconut shell activated carbon cartridge with KDF 2 O-rings | SL | 2" x 10" |



| | | | |
|--------------------|--|-----|-----------------|
| FCCBKDF5 | UDF type GAC coconut shell activated carbon cartridge with KDF | DOE | 2 1/2" x 4 7/8" |
| FCCBKDF | UDF type GAC coconut shell activated carbon cartridge with KDF | DOE | 2 1/2" x 9 7/8" |
| FCCBKDF-L | UDF type GAC coconut shell activated carbon cartridge with KDF | DOE | 2 1/2" x 20" |
| FCCBKDF10BB | UDF type GAC coconut shell activated carbon cartridge with KDF | DOE | 4 1/2" x 9 7/8" |
| FCCBKDF20BB | UDF type GAC coconut shell activated carbon cartridge with KDF | DOE | 4 1/2" x 20" |
| FCCBKDF-STO | UDF type two stage filtration sediment GAC coconut shell activated carbon cartridge with KDF | DOE | 2 1/2" x 4 7/8" |



BN3



BN2



BN1



SL



U



I



QF



NPT

CARBON CARTRIDGES

ICONS APPENDIX ON THE LAST PAGE

ACC-3 GAC ACTIVATED CARBON CARTRIDGES / KDF



CATALOG NUMBER DESCRIPTION CONNECTION SIZE



| | | | |
|---------------------|---|-----|-----------------|
| FCCBKDF2 | UDF type GAC coconut shell activated carbon cartridge with KDF and ION exchange resin | DOE | 2 1/2" x 9 7/8" |
| FCCBKDF210BB | UDF type GAC coconut shell activated carbon cartridge with KDF and ION exchange resin | DOE | 4 1/2" x 9 7/8" |
| FCCBKDF220BB | UDF type GAC coconut shell activated carbon cartridge with KDF and ION exchange resin | DOE | 4 1/2" x 20" |

ACC-4 CARBON BLOCK CARTRIDGES



ACC-4 Series cartridges have a high porosity design that helps prevent the cartridge from plugging before its adsorption capability is exhausted, maximizing the utilization of the carbon while maintaining low pressure drop.

ACC-4 series Aquafilter carbon Block filter cartridge for VOC reduction is manufactured by extrusion, using mix blend GAC granular activated carbon media for improved reduction of chlorine taste and odor, and high adsorptive capacity. The 5-micron carbon block and is ideal for use as a reverse osmosis prefilter or postfilter.

A common complaint of all types of Granular Activated Carbon (GAC) filters is higher than carbon block, reduced flow and water forming channels thru the GAC media which results in less contact time and absorption.

Unlike GAC filters, carbon block cartridges will not channel or bypass due to the extreme uniformity of their extruded activated carbon core. Service life of block carbon filters is greatly extended by a prefiltration medium.

Antibacterial carbon block Nano silver water filter cartridge

Activated carbon block made from coconut shell, providing fine sediment filtration and reduction of chlorine, taste, odor (CTO) and volatile organic compounds (VOC). Silver impregnated models for bacteriostatic filtration effect.

Silver has natural antibacterial and antifungal capability, it acts as catalyst that disable the enzyme which viruses, bacteria and fungi needed for their oxygen metabolism, suffocates them without harming human body.

CATALOG NUMBER DESCRIPTION CONNECTION SIZE



| | | | |
|---------------------|---|-----|--------------|
| FCCBL-L-AQ | In-line carbon block cartridge - 1/4" | NPT | 2 1/2" x 12" |
| FCCBL-L38-AQ | In-line carbon block cartridge - 3/8" | NPT | 2 1/2" x 12" |
| FCCBL-L-QC | In-line carbon block cartridge - 1/4" | QF | 2 1/2" x 12" |
| FCCBL-L38-QC | In-line carbon block cartridge - 3/8" | QF | 2 1/2" x 12" |
| FCCBL-S-CL | In-line carbon block cartridge - 1/4" (transparent) | NPT | 2 1/2" x 12" |
| FCCBL-S-TW | Twist type carbon block cartridge | BN1 | 2 1/2" x 12" |
| VO-86 | Twist type carbon block cartridge | BN2 | 2 1/2" x 12" |
| U-86 | In-line carbon block cartridge - 3/8" | U | 2 1/2" x 12" |
| FCCBL-CT | Candle carbon block cartridge with thread | SL | 2" x 10" |



| | | | |
|------------------|----------------------|-----|-----------------|
| FCCBL5 | Economy carbon block | DOE | 2 1/2" x 4 7/8" |
| FCCBL | Economy carbon block | DOE | 2 1/2" x 9 7/8" |
| FCCBL-L | Economy carbon block | DOE | 2 1/2" x 20" |
| FCCBL10BB | Economy carbon block | DOE | 4 1/2" x 9 7/8" |
| FCCBL20BB | Economy carbon block | DOE | 4 1/2" x 20" |



BN3



BN2



BN1



SL



U



I



QF



NPT

CARBON CARTRIDGES

ICONS APPENDIX ON THE LAST PAGE

ACC-4 CARBON BLOCK CARTRIDGES



CATALOG NUMBER DESCRIPTION CONNECTION SIZE

| | | | |
|--------------------|--|-----|-----------------|
| FCCBL5-S | Coconut shell activated carbon block cartridge | DOE | 2 1/2" x 4 7/8" |
| FCCBL-S | Coconut shell activated carbon block cartridge | DOE | 2 1/2" x 9 7/8" |
| FCCBL-L-S | Coconut shell activated carbon block cartridge | DOE | 2 1/2" x 20" |
| FCCBL10BB-S | Coconut shell activated carbon block cartridge | DOE | 4 1/2" x 9 7/8" |
| FCCBL20BB-S | Coconut shell activated carbon block cartridge | DOE | 4 1/2" x 20" |

SILVER IMPREGNATED CARBON BLOCK



| | | | |
|-----------------------|--|-----|-----------------|
| FCCBL-S-L-AQ | In-line silver impregnated carbon block cartridge - 1/4" | NPT | 2 1/2" x 12" |
| FCCBL-S-L38-AQ | In-line silver impregnated carbon block cartridge - 3/8" | NPT | 2 1/2" x 12" |
| FCCBL-S-L-QC | In-line silver impregnated carbon block cartridge - 1/4" | QF | 2 1/2" x 12" |
| FCCBL-S-L38-QC | In-line silver impregnated carbon block cartridge - 3/8" | QF | 2 1/2" x 12" |
| VO-88 | Twist type silver impregnated carbon block cartridge | BN2 | 2 1/2" x 12" |
| FCCBL-S-TW2 | Twist type silver impregnated carbon block cartridge | BN3 | 2 1/2" x 12" |
| U-88 | In-line silver impregnated carbon block cartridge | U | 2 1/2" x 12" |
| FCCBL-S-SL | Slim type silver impregnated carbon block cartridge 2 O-rings | SL | 2" x 10" |
| FCCBL-G-AB | Silver impregnated coconut shell activated block cartridge | DOE | 2 1/2" x 9 7/8" |
| FCPS5-BL-AB | Two stage bacteriostatic sediment and silver impregnated coconut shell | DOE | 2 1/2" x 9 7/8" |

ACC-5 OTHER TYPE CARTRIDGES



CATALOG NUMBER DESCRIPTION CONNECTION SIZE



| | | | |
|---------------------|---|-----|-----------------|
| AICRO-SOF | In-line GAC coconut shell activated carbon / scale reduction cartridge - 1/4" | NPT | 2" x 10" |
| AICRO-SOF-QC | In-line GAC coconut shell activated carbon / scale reduction cartridge - 1/4" | QF | 2" x 10" |
| VO-90 | Twist type GAC coconut shell activated carbon / scale reduction cartridge | BN2 | 2 1/2" x 12" |
| U-90 | In-line GAC coconut shell activated carbon / scale reduction cartridge - 3/8" | U | 2 1/2" x 12" |
| FCPRA5-C | UDF type GAC coconut shell activated carbon / scale reduction cartridge | DOE | 2 1/2" x 9 7/8" |
| FCPRA-C | UDF type GAC coconut shell activated carbon / scale reduction cartridge | DOE | 4 1/2" x 9 7/8" |



ACR-1 WATER SOFTENING RESIN CARTRIDGES



ACR-1 series utilizes FDA-grade, sodium, based, strongly acidic ion-exchange resin which reduces calcium and magnesium ion content in water. Calcium and magnesium are often called "hardness minerals". Large amounts of these ions in water are responsible for the formation of scale deposits, higher detergent consumption and stains on glassware. In extreme cases large amounts of calcium and magnesium can lead to glass etching.

Hard water damages home appliances such as: dishwashers and washing machines, and increases their energy consumption. Hard water leaves an invisible film on skin, which blocks pores. This in turns causes chapping, itching and dryness. Softened water contains almost no calcium & magnesium. It enables people to use lesser quantities of soap, shampoo, and skin care products. Moreover, detergent consumption is reduced.

Aquafilter ACR-1 series can be used in every POE or POU application where soft water is required.









Large selection also available in difrent size and length inline 2" and 2 1/2" cartridges with all type connections as specified below.

Model - two stage filtration features sediment and ion exchange layers. The first layer removes sediments and mechanical contaminants up to 10 micron. The second layer with ion exchange media acts as water softener.

Their undeniable benefit is ease of installation and service. Cartridges include pre-filter and post-filters, preventing media particles from being washed out.

Cartridges are available in various capacities to meet customer demands. ASR-1 series was designed to allow optimal contact between water and resin therefore ensuring maximum performance (ion exchange).

| CATALOG NUMBER | DESCRIPTION | CONNECTION | SIZE |
|----------------|-------------|------------|------|
|----------------|-------------|------------|------|

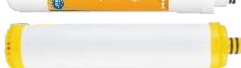
| | | | |
|---|--|-----|--------------|
|  | AISTRO In-line water softening cartridge - 1/4" | NPT | 2" x 10" |
|  | AISTRO-QC In-line water softening cartridge - 1/4" | QF | 2" x 10" |
|  | AISTRO-L-AQ In-line water softening cartridge - 1/4" | NPT | 2 1/2" x 12" |
|  | AISTRO-L-QC In-line water softening cartridge - 1/4" | QF | 2 1/2" x 12" |
|  | AISTRO-L38-QC In-line water softening cartridge - 3/8" | QF | 2 1/2" x 12" |
|  | AISTRO-L-CL In-line water softening cartridge - 1/4" (transparent) | NPT | 2 1/2" x 12" |
|  | AISTRO-L-CL-QC In-line water softening cartridge - 3/8" (transparent) | QF | 2 1/2" x 12" |
|  | VO-85 Twist type water softening cartridge | BN2 | 2 1/2" x 12" |
|  | U-85 In-line water softening cartridge - 3/8" | U | 2 1/2" x 12" |
|  | FCCST-SL Candle type water softening cartridge 2 O-rings | SL | 2" x 10" |



| | | | |
|------------------|--|-----|-----------------|
| FCCST5 | UDF type water softening cartridge | DOE | 2 1/2" x 4 7/8" |
| FCCST | UDF type water softening cartridge | DOE | 2 1/2" x 9 7/8" |
| FCCST-L | UDF type water softening cartridge | DOE | 2,5" x 20" |
| FCCST10BB | UDF type water softening cartridge | DOE | 4 1/2" x 9 7/8" |
| FCCST20BB | UDF type water softening cartridge | DOE | 4 1/2" x 20" |
| FCCST-STO | UDF type two stage filtration sediment and water softening cartridge | DOE | 2 1/2" x 4 7/8" |



BN3



BN2



BN1



SL



U



I



QF



NPT

RESIN CARTRIDGES

ICONS APPENDIX ON THE LAST PAGE

ACR-1 WATER SOFTENING RESIN CARTRIDGES



| CATALOG NUMBER | DESCRIPTION | CONNECTION | SIZE |
|----------------|---|------------|-----------------|
| FCCST2 | UDF type water softening and iron reduction cartridge | DOE | 2 1/2" x 9 7/8" |
| FCPRA-5 | UDF type scale reduction cartridge | DOE | 2,5" x 4 7/8" |
| FCPRA-10 | UDF type scale reduction cartridge | DOE | 2 1/2" x 9 7/8" |
| FCPNN-SCALE | Sediment nylon net with scale reduction cartridge | DOE | 2 1/2" x 9 7/8" |
| FCPRA-W | UDF type scale reduction cartridge | DOE | 2 1/2" x 9 7/8" |
| FCPRA-20W-L | UDF type scale reduction cartridge | DOE | 2 1/2" x 20" |
| FCPRA-10BBW | UDF type scale reduction cartridge | DOE | 4 1/2" x 9 7/8" |
| FCPRA-20BBW | UDF type scale reduction cartridge | DOE | 4 1/2" x 20" |

ACR-2 IRON REDUCTION CARTRIDGE / WATER SOFTENING



Through its accurate combination of double bed media, cartridges perform a pH adjustment of your drinking water followed by a reduction of iron and manganese concentration, diminishing the metallic taste of your drinking water with advanced blend filtration media for more effective water treatment.

Iron in a concentration as low as 0,3 mg/l can become a source of yellow to dark-brown stains often found in sinks, toilets and other plumbing fixtures. If iron is present in detectable amounts it can ruin the taste of tea, coffee and beverages.

Iron salts may irritate skin. Manganese is much more annoying than iron. Even low concentrations of this element (> 0,05 mg/l) create dark-brown or black stains on everything with which it comes in contact. Both manganese and iron form deposits inside piping systems, which (after a while) may severely reduce flow.

| CATALOG NUMBER | DESCRIPTION | CONNECTION | SIZE |
|----------------|--|------------|-----------------|
| FCCFE-SL | Candle type water iron reduction cartridge 2 O-rings | SL | 2" x 10" |
| AISTRO-2 | In-line water softening and iron reduction cartridge - 1/4" | NPT | 2" x 10" |
| AISTRO-2-QM | In-line water softening and iron reduction cartridge - 1/4" | I | 2 1/2" x 12" |
| AISTRO-2-TW | Twist type water softening and iron reduction cartridge | BN1 | 2 1/2" x 12" |
| AISTRO-2-TW2 | Twist type water softening and iron reduction cartridge | BN3 | 2 1/2" x 12" |
| FCCST2-SL | Candle type water softening and iron reduction cartridge 2 O-rings | SL | 2" x 10" |
| FCCFE5 | UDF type water iron reduction cartridge | DOE | 2 1/2" x 4 7/8" |
| FCCFE | UDF type water iron reduction cartridge | DOE | 2 1/2" x 9 7/8" |
| FCCFE-L | UDF type water iron reduction cartridge | DOE | 2 1/2" x 20" |
| FCCFE10BB | UDF type water iron reduction cartridge | DOE | 4 1/2" x 9 7/8" |
| FCCFE20BB | UDF type water iron reduction cartridge | DOE | 4 1/2" x 20" |



RESIN CARTRIDGES

ICONS APPENDIX ON THE LAST PAGE

ACR-3 WATER DEIONIZATION CARTRIDGE











ACR-3 Aquafilter DI is a new series of deionization in-line filter cartridges. Cartridge are filled with a mixture of both cationic and anionic ion exchange resins. Cartridges are mostly utilized as a last stage of water filtration, after RO membrane. They effectively remove remaining ions which were left, leaving totally deionized water.

Applications:

1. Medical (stomatology)
2. Laboratories
3. Aquariums
4. Electrical (water for car batteries)
5. Household goods (humidifiers, irons, etc.)

| CATALOG NUMBER | DESCRIPTION | CONNECTION | SIZE |
|----------------|-------------|------------|------|
|----------------|-------------|------------|------|

| | | | |
|---|--|-----|-----------------|
|  | AISTRO-DI In-line deionization filter cartridge 1/4" | NPT | 2" x 10" |
|  | AISTRO-DI-L-AQ In-line deionization filter cartridge 1/4" | NPT | 2 1/2" x 12" |
|  | AISTRO-DI-L38-AQ In-line deionization filter cartridge 3/8" | QF | 2 1/2" x 12" |
|  | AISTRO-DI-QM In-line deionization filter cartridge 1/4" | I | 2 1/2" x 12" |
|  | VO-89 Twist type deionization filter cartridge | BN2 | 2 1/2" x 12" |
|  | U-89 In-line deionization filter cartridge 3/8" | U | 2 1/2" x 12" |
|  | FCCSDI-SL Candle deionization cartridge 2 O-rings | SL | 2" x 10" |
|  | FCCSDI10 UDF type deionization cartridge | DOE | 2 1/2" x 9 7/8" |
| | FCCSDI20 UDF type deionization cartridge | DOE | 2 1/2" x 20" |
| | FCCSDI10BB UDF type deionization cartridge | DOE | 4 1/2" x 9 7/8" |
| | FCCSDI20BB UDF type deionization cartridge | DOE | 4 1/2" x 20" |

MINERAL PH ADJUSTMENT CARTRIDGES



ICONS APPENDIX ON THE LAST PAGE

ACM-3 IONIZE FILTER CARTRIDGES



Through an accurate negative ionized ceramic media, AIFIR2000 provides water with negatively charged atoms and complex particles (i.e. higher number of electrons than usual in your tap water). Studies have indicated the potential health benefits of negative ionized water, easily absorbed by the human body that can positively affect many physiological processes such as aging, stress, balancing pH level of body fluids and reducing cancer development.

| CATALOG NUMBER | DESCRIPTION | CONNECTION | SIZE |
|----------------|-------------|------------|------|
|----------------|-------------|------------|------|

| | | | |
|---|--|-----|----------|
|  | AIFIR2000 In-line negative ion cartridge 1/4" (transparent) | NPT | 2" x 11" |
|  | AIFIR-200 In-line alkalizer cartridge, 1/4" NPT (transparent) | NPT | 2" x 11" |



BN3



BN2



BN1



SL



U



I



QF



NPT

MINERAL PH ADJUSTMENT CARTRIDGES

ICONS APPENDIX ON THE LAST PAGE

ACM-1 ALKALINE / ORP CARTRIDGES



The Alkalizing, ORP & Mineralizing cartridge filter will provide you with enhanced water, which is alkaline, remineralized, energized and has a low ORP with one of the best oxygen absorption rates in your body possible.

The ACM-1 cartridge filter is ideal for those who are looking to reduce the amount acidic toxic waste in the blood, tissues and fluids of the body and help adhere to the more alkaline state required by the human metabolic process. By drinking alkaline water will help your body dissolve acid waste, making it easier for the body dispose of them safely. The accumulation of acid wastes is aging our bodies and the reduction of these acid wastes is anti-aging. If water or media has a negative ORP it has the ability to decrease the oxidation which will prolong the life of another substance or body. The filter will significantly increase the negative ORP and enable it to decrease the oxidation of other substances or bodies by being a potent anti-oxidant.

| CATALOG NUMBER | DESCRIPTION | CONNECTION | SIZE |
|----------------|-------------|------------|------|
|----------------|-------------|------------|------|

| | | | |
|-----------------------|--|-----|--------------|
| AIFIR-ALK-RO | In-line alkaline / ORP cartridge for RO systems 1/4" | NPT | 2" x 11" |
| AIFIR-ALK-ROQC | In-line alkaline / ORP cartridge for RO systems 1/4" | QF | 2" x 10" |
| AIFIR-ALK-DF | In-line alkaline / ORP cartridge for RO systems 1/4" | NPT | 2 1/2" x 12" |
| AIFIR-ALK-DFQC | In-line alkaline / ORP cartridge for RO systems 1/4" | QF | 2 1/2" x 12" |
| AIFIR-250 | In-line alkaline / ORP cartridge for RO systems 1/4" (transparent) | QF | 2 1/2" x 12" |









ACM-2 MINERAL FILTER CARTRIDGES



After RO mineral cartridge, water passing through several stages is enriched with natural microelements such as calcium and magnesium.

These beneficial minerals and nutrients are added back (after being removed by RO) to water to create a mineralized, pH-balanced result. These media alkalize and remineralize water, raising its pH. They reduce acidity in the body and produce natural calcium and magnesium ions that can be absorbed by the human body.

| CATALOG NUMBER | DESCRIPTION | CONNECTION | SIZE |
|----------------|-------------|------------|------|
|----------------|-------------|------------|------|

| | | | | |
|---|-----------------|---|-----|--------------|
|  | AIMRO | In-line mineral filter cartridge 1/4" | NPT | 2" x 10" |
|  | AIMRO-QC | In-line mineral filter cartridge 1/4" | QF | 2" x 10" |
|  | AIFIR-M | In-line mineral filter cartridge 1/4" (transparent) | NPT | 2" x 11" |
|  | FCCM-TW | In-line mineral filter cartridge | BN1 | 2 1/2" x 12" |
|  | VO-87 | In-line mineral filter cartridge | BN2 | 2 1/2" x 12" |
|  | FCCM-TW2 | In-line mineral filter cartridge | BN3 | 2 1/2" x 12" |
|  | U-87 | In-line mineral filter cartridge 3/8" | U | 2 1/2" x 12" |
|  | FCCM-SL | Candle mineral cartridge with 2 O-rings | SL | 2" x 10" |



BN3



BN2



BN1



SL



U



I



QF



NPT

ACA-1 SETS OF CARTRIDGES



EXCITO-B-CLR-CRT

The set of cartridges for EXCITO-B :

- AIPRO-20M-QM
 - AISTRO-2-QM
 - AICRO-3-QM
 - AICRO-4-QM
- Packed in color box,
2,5" x 12" - 1/4" QM



EXCITO-ST-CRT

The set of four cartridges for EXCITO and EXCITO-ST :

- AIPRO-20M-AQ
 - AISTRO-L-AQ
 - AICRO-L4-AQ
 - AIPRO-1M-AQ
- Packed in color box,
2,5" x 12" - 1/4" NPT



EXCITO-CRT

The set of four cartridges for EXCITO and EXCITO-ST :

- AIPRO-20M-AQ
 - AIPRO-1M-AQ
 - AICRO-L-AQ
 - AICRO-L4-AQ
- Packed in color box,
2,5" x 12" - 1/4" NPT



EXCITO-CLR-CRT

The set of four cartridges for EXCITO and EXCITO-ST :

- AIPRO-20M-AQ
 - AIPRO-3-L-AQ
 - AICRO-L-AQ
 - AICRO-L4-AQ
- Packed in color box,
2,5" x 12" - 1/4" NPT



EXCITO-HF-CRT

The set of three cartridges for EXCITO and EXCITO-ST :

- AIPRO-20M-AQ
 - AIPRO-3-L-AQ
 - AICRO-L4-AQ
- Packed in color box,
2,5" x 12" - 1/4" NPT



FP3-K1-CRT

The set of three cartridges for FP3-K1, FP3-HJ-K1, FP3 2 undercounter systems:

- FCPS5
 - FCCST2
 - FCCBKDF
- Packed in color box



FP3-CRT

The set of three cartridges for FP3-K1, FP3-HJ-K1, FP3-2 undercounter and Reverse Osmosis systems:

- FCPS5
 - FCPS20
 - FCCBL
- Packed in color box



EXCITO-CL-CRT

Set of three cartridges for EXCITO-CL:

- AIPRO-1M-CL
 - AISTRO-L-CL
 - FCCBL-S-CL
- 2,5" x 12" - 1/4" NPT



RX-AFRO3-AQ-CRT

Cartridge sets for 3 stage RO system for aquarium:

- AICRO
- AIPRO



BN3



BN2



BN1



SL



U



I



QF



NPT

SPECIAL TYPE CARTRIDGES

ICONS APPENDIX ON THE LAST PAGE

ACA-2 RO MEMBRANES















RO membranes consists of many thin layers of porous, semi-permeable film wound around a central core.

ACA-2 series membranes are compatible with most RO systems available on the market. Membranes are available in various capacities: 50GPD, 75GPD, 100GPD & 125GPD to meet customers demands.

They effectively remove 96%-99% of suspended particles, most bacteria and viruses, VOC's (not smaller than 0.0001 µm) and even ions.



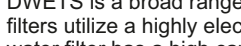
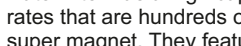





ACA-2 series membranes improve overall quality of water. Keep in mind that the performance of the RO membranes depends on water temperature and applied pressure. Low temperature of influent water will affect (lower) membrane performance. Pressure has a similar effect. In such cases, booster pump is required. All filtered impurities are flushed to drain.

| | CATALOG NUMBER | DESCRIPTION | CONNECTION | SIZE |
|---|--------------------|--|------------|--------------|
|  | TFC-70F-TW | Twist type encapsulated RO membrane 70 gpd | BN1 | 2 1/2" x 12" |
|  | VO-80 | Twist type encapsulated RO membrane 70 gpd | BN2 | 2 1/2" x 12" |
|  | TFC-70F-TW2 | Twist type encapsulated RO membrane 70 gpd | BN3 | 2 1/2" x 12" |
|  | U-80 | In-line encapsulated RO membrane 70 gpd | U | 2 1/2" x 12" |
|  | TLC50FT | Ro membrane elements Filmtec™ brand 50 gpd | SL | 2012 |
|  | TLC75FT | Ro membrane elements Filmtec™ brand 75 gpd | SL | 2012 |
|  | TFC-50F | Ro membrane elements aquafilter brand 50 gpd | SL | 2012 |
|  | TFC-75F | Ro membrane elements aquafilter brand 75gpd | SL | 2012 |
|  | TFC-100F | Ro membrane elements aquafilter brand 100 gpd | SL | 2012 |
|  | TFC-200F | Ro membrane elements aquafilter brand 200 gpd | SL | 2012 |
|  | TFC-200 | Ro membrane elements aquafilter brand 200 gpd | SL | 3012 |
|  | TFC-300 | Ro membrane elements aquafilter brand 300 gpd | SL | 3012 |
|  | TFC-600 | Ro membrane elements aquafilter brand 600 gpd | SL | 3012 |
|  | TFC-1000 | Ro membrane elements aquafilter brand 1000 gpd | SL | SPECIAL |

ACA-3 SPECIAL TYPE CARTRIDGES

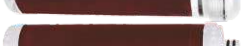

DWETS is a broad range of cartridges with spectrum particle adsorber that provides greater filtration than conventional filters. DWETS filters utilize a highly electropositive filter media that rapidly adsorbs particles, no matter how small. As a result, each electropositive water filter has a high capacity for particles as small as a few nanometers. Cartridge exhibits an absolute rating of 0.2 microns with flow rates that are hundreds of times greater than other type filters. ACA-4 series of pleated filter cartridges act as a broad-spectrum particle super magnet. They feature a thermally bonded blend of micro glass fibers & cellulose infused with nanoalumina fibers in a non-woven matrix. By using the scientific principle of electropositive attraction / capture, the technology leads to a rapid and highly efficient adsorption of virtually all particle sizes. When assembled into a pleated cartridge, DWETS offers a unique combination of efficiency, capacity, flow rate & super low pressure drop.

| | CATALOG NUMBER | DESCRIPTION | CONNECTION | SIZE |
|---|------------------|---|------------|-----------------|
|  | TLCHF-ALK | In-line post RO alkaline and ultrafiltration 1/4" (transparent) | QF | 2" x 11" |
|  | VO-94 | Twist type nanofiltration cartridge remove bacteria and virus | BN2 | 2 1/2" x 12" |
|  | DW-SL | In-line nanofiltration cartridge remove bacteria and virus 1/4" (transparent) | QF | 2" x 11" |
|  | U-94 | U type push in nanofiltration cartridge remove bacteria 3/8" | U | 2 1/2" x 12" |
|  | FCNANO-SL | Candle type nanofiltration cartridge remove bacteria and virus 2 o-rings | SL | 2" x 10" |
|  | TAIP-CL | In-line multi application filter cartridge 1/4" (transparent) | NPT | 2" x 11" |
|  | TAIP-L-CL | In-line multi application filter cartridge 1/4" (transparent) | NPT | 2 1/2" x 12" |
|  | TAIP-SL | Candle type multi application cartridge 2 o-rings | SL | 2" x 10" |
|  | TAIP | Special 10" multi application cartridge | DOE | 2 1/2" x 9 7/8" |
|  | FCNANO | Special 10" nanofiltration cartridge for bacteria and virus reduction | DOE | 2 1/2" x 9 7/8" |



BN3



BN2



BN1



SL



U



I



QF



NPT









ACA-4 EMPTY CARTRIDGE HOUSINGS

The **ACA-4** empty cartridge with its threaded end caps enables repeated media change-outs, allowing complete freedom of media selection. Suitable for use with resins, granular activated carbon or a special media of your choice.

- Available in transparent and white inline 2" and 2 1/2" diameter standard 10" 11" and 12" lengths
- Available in 10" and 20" lengths, standard and large diameter UDF type
- Internal pre and post filters protect the media and prevent potential migration
- Pre and post filtration pads prevent media migration, providing quality permeate pre filter: 100-micron, post filter: 20-micron
- Fits standard and large diameter filter housings
- The ACA-4 PET transparent in-line empty cartridges an environmentally friendly refillable design, allowing for a multitude of medias to be used
- ACA-4A PET shells offer an ideal and versatile solution for trials or testing applications pre full scale production
- Constructed from durable, highly transparent PET material to ensure color changing media can clearly be seen, ideal for maintaining resin quality and phosphate usage
- Simple, quick and secure 1/4" and 3/8" NPT and John Guest quick connections for easy and safe installation
- Buna-N O-Ring alongside threaded end-cap to create an extremely secure seal

Inline Filter with  insert fittings



| | CATALOG NUMBER | DESCRIPTION | CONNECTION | SIZE |
|---|----------------------------|---|------------|-----------------|
|  | AICRO-E-THR | In-line reusable white empty cartridge 1/4" | NPT | 2" x 11" |
|  | AICRO-E-THR-QC | In-line reusable white empty cartridge 1/4" | QF | 2" x 11" |
|  | AICRO-E-2CL-THR | In-line reusable transparent empty cartridge 1/4" | NPT | 2" x 11" |
|  | AICRO-E-2CL-QC | In-line reusable transparent empty cartridge 1/4" | QF | 2" x 11" |
|  | AICRO-E-212-THR | In-line reusable white empty cartridge 1/4" | NPT | 2 1/2" x 12" |
|  | AICRO-E-212-THR38 | In-line reusable white empty cartridge 3/8" | NPT | 2 1/2" x 12" |
|  | AICRO-E-212THR-QC | In-line reusable white empty cartridge 1/4" | QF | 2 1/2" x 12" |
|  | AICRO-E-212THR38-QC | In-line reusable white empty cartridge 3/8" | QF | 2 1/2" x 12" |
|  | AICRO-E-212CL-THR | In-line reusable transparent empty cartridge 1/4" | NPT | 2 1/2" x 12" |
|  | AICRO-E-212CL-THR38 | In-line reusable transparent empty cartridge 3/8" | NPT | 2 1/2" x 12" |
|  | AICRO-E-212CL-QC | In-line reusable transparent empty cartridge 3/8" | QF | 2 1/2" x 12" |
|  | FCEB5 | Reusable transparent empty cartridge 5" | DOE | 2 1/2" x 4 7/8" |
|  | FCEB10 | Reusable transparent empty cartridge 10" | DOE | 2 1/2" x 9 7/8" |
|  | FCEB10-WC | Reusable transparent empty cartridge 10" | DOE | 2 1/2" x 9 7/8" |
|  | FCEB10-WW | Reusable white empty cartridge 10" | DOE | 2 1/2" x 9 7/8" |
|  | FCEB10-10BB | Reusable white jumbo BB empty cartridge 10" | DOE | 4 1/2" x 9 7/8" |
|  | FCEB10-20BB | Reusable white jumbo BB empty cartridge 20" | DOE | 4 1/2" x 20" |





AV-CART VO CARTRIDGES



VO-80
RO Membrane 70 GPD



VO-82
Sediment filtration cartridge 5 micron



VO-83
Granular activated carbon (GAC) cartridge



VO-85
Water softening cartridge



VO-86
Coconut shell activated carbon block cartridge



VO-87
Mineral and Ph regulating cartridge



VO-88
Granular Activated Carbon GAC with KDF bacteriostatic cartridge



VO-89
Demineralization mixed bed resin cartridge



VO-90
Activated carbon with KDF and polyphosphate cartridge



VO-91
Ultrafiltration membrane (UF) for domestic water treatment



VO-92
Carbon block cartridge



VO-94
Nanofiltration cartridge for virus, bacteria and heavy metal cartridge

AV-VOH FILTER HEADS FOR VO CARTRIDGES



VOH-1
Single head with metal bracket and 3/8" quick connectors



VOH-4
Four stage head assembly with metal bracket and 3/8" quick connectors



VOH-2
Double head assembly with metal bracket and 3/8" quick connectors



VOH-3
Triple head assembly with metal bracket and 3/8" quick connectors

AV-VOA ACCESSORIES FOR VO



VOA-1
Connecting valve, euro type faucet with 3/8" tubing and all accessories for easy installation



VOA-2
Connecting valve, faucet with 1/4" tubing and all accessories for easy installation





SALES@AQUAFILTER.COM



DISTRIBUTOR

more info



ALL AQUAFILTER IMAGES, TRADEMARKS, LOGOS AND OTHER INTELLECTUAL PROPERTY ARE THE SOLE AND EXCLUSIVE PROPERTY OF AQUAFILTER INC. AND MAY NOT BE USED WITHOUT OUR EXPRESS WRITTEN PERMISSION.



Made in EU



AQUAFILTER EUROPE

UL. ŚW. TERESY 101
91-222 ŁÓDŹ, POLAND

WWW.AQUAFILTER.COM



AQUAFILTER GERMANY



AQUAFILTER BELARUS

ADVANTA SYSTEM,
KRASNOGARDEYSKAYA
114B/5 224024 BREST,
BELARUS





MADE IN EU

AC



AA



AS AE AU AR



AH



AH CATALOG

WWW.AQUAFILTER.COM

FILTER HOUSINGS



AH



AH FILTER HOUSINGS

AH FILTER HOUSINGS

TWO PART FILTER HOUSINGS 1

- AH-H10K - 10" filter housings with 2 O-rings
- AH-H10D - 10" filter housings with 2 O-rings
- AH-H10B - 10" double O-ring filter housings 2
- AH-H10C - 10" high pressure filter housings

THREE PART FILTER HOUSINGS 3

- AH-H051020 - 5", 10" and 20" three part filter housings
- AH-H05A - 5" three part slim filter housings 5
- AH-H10G - 10" three part slim line filter housings

THREE PART SPIN-DOWN FILTER HOUSINGS 6

- AH-H10G - 10" three part spin-down filter housings
- AH-H3SLV - three part spin-down filter housings 7

SPECIAL TYPE FILTER HOUSINGS 8

- AH-H105 - 10" high temperature filter housings
- AH-HSH1 - brass sediment filter
- AH-HM20 - RO membrane housings

BIG BLUE FILTER HOUSINGS 9

- AH-HB1D - 10" Big Blue filter housings
- AH-HB2D - 20" Big Blue filter housings

BIG BLUE FILTER HOUSINGS WITH BRASS INSERTS 10

- AH-HB1B - 10" Big Blue filter housings with brass inserts
- AH-HB2B - 20" Big Blue filter housings with brass inserts

AH-SLIM SUPER SLIM TWO PART FILTER HOUSINGS 11



TWO PART FILTER HOUSINGS



AH-H10K 10" FILTER HOUSINGS WITH 2 O-RINGS

AQUAFILTER AH-H10K SERIES

TWO PART FILTER HOUSINGS WITH DOUBLE O-RINGS ensures maximum leak-proof performance are available in transparent or white sump, white head and are made to store broad range of 2 1/2" x 9 7/8" diameter cartridges widely available on the market. Connections are available in 1/4", and 3/8" female NPT ports.

AQUAFILTER AH-H10K SERIES FILTER HOUSINGS are WRAS certified for material and structural integrity and ideal for typical applications as pre and post-filtration for RO systems, under sink filters, counter top systems, ice machines, food service and other residential and industrial applications.

WHITE SUMP



part no. **EG14WWAQ-4** size **1/4" NPT**

TRANSPARENT SUMP



part no. **EG14CWAQ-4** size **1/4" NPT**

AH-H10D 10" FILTER HOUSINGS WITH 2 O-RINGS

AQUAFILTER AH-H10D SERIES

TWO PART FILTER HOUSINGS WITH DOUBLE O-RINGS ensures maximum leak-proof performance are available in a variety of colors and are made to store broad range of 2 1/2" x 9 7/8" diameter cartridges widely available on the market. Connections are available in 1/4", and 3/8" female NPT ports and 1/2", 3/4" and 1" female BSP ports

AQUAFILTER AH-H10D SERIES FILTER HOUSINGS are WRAS certified for material and structural integrity and ideal for typical applications as pre and post-filtration for RO systems, under sink filters, counter top systems, ice machines, food service and other residential and industrial applications.

WHITE SUMP



part no. **FHPLWW14-NPT-D** size **1/4" NPT**
FHPLWW38-NPT-D size **3/8" NPT**

TRANSPARENT SUMP



part no. **FHPLW14-NPT-D** size **1/4" NPT**
FHPLW38-NPT-D size **3/8" NPT**

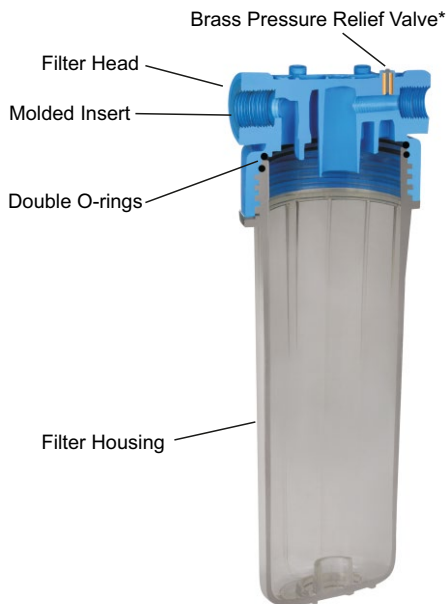

BLUE SUMP



part no. **FHPLN14-NPT-D** size **1/4" NPT**
FHPLN38-NPT-D size **3/8" NPT**
FHPLN12-BSP-D size **1/2" BSP***
FHPLN34-BSP-D size **3/4" BSP***
FHPLN1-BSP-D size **1" BSP***

TRANSPARENT SUMP



part no. **FHPL14-NPT-D** size **1/4" NPT**
FHPL38-NPT-D size **3/8" NPT**
FHPL12-BSP-D size **1/2" BSP***
FHPL34-BSP-D size **3/4" BSP***
FHPL1-BSP-D size **1" BSP***

TWO PART FILTER HOUSINGS

AH-H10B 10" DOUBLE O-RING FILTER HOUSINGS

AQUAFILTER AH-H10B SERIES

TWO PART FILTER HOUSINGS WITH DOUBLE O-RINGS ensures maximum leak-proof performance are available in a transparent or blue sump, blue head with pressure relief (PR) valve and are made to store broad range of 2 1/2" x 9 7/8" diameter cartridges widely available on the market. Brass insert connections are available in 1/2", 3/4" and 1" female BSP ports.

AQUAFILTER AH-H10B SERIES FILTER HOUSINGS are WRAS certified for material and structural integrity and ideal for typical applications as point of entry (POE) pre and post-filtration as well point of use (POU) such under sink filter systems, ice machines, food service and other residential and industrial applications.

Filter Housing Set includes: Filter housing, FCPS5 sediment 5 micron cartridge, mounting bracket with screws, wrench, and bacteriostatic filter centralizing ring packed in color box.

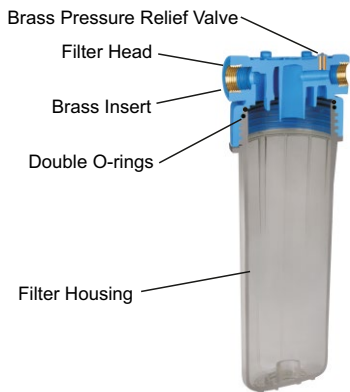

TRANSPARENT SUMP

BLUE SUMP

SINGLE



| part no. | size |
|-------------|----------|
| FHPR12-B-AQ | 1/2" BSP |
| FHPR34-B-AQ | 3/4" BSP |
| FHPR1-B-AQ | 1" BSP |

| part no. | size |
|----------|----------|
| FHPRN12 | 1/2" BSP |
| FHPRN34 | 3/4" BSP |
| FHPRN1 | 1" BSP |

SET



| part no. | size |
|--------------|----------|
| FHPR12-B1-AQ | 1/2" BSP |
| FHPR34-B1-AQ | 3/4" BSP |
| FHPR1-B1-AQ | 1" BSP |

| part no. | size |
|---------------|----------|
| FHPRN12-B1-AQ | 1/2" BSP |
| FHPRN34-B1-AQ | 3/4" BSP |
| FHPRN1-B1-AQ | 1" BSP |

AH-H10C 10" HIGH PRESSURE FILTER HOUSINGS

AQUAFILTER AH-H10C SERIES

TWO PART HIGH PRESSURE FILTER HOUSINGS WITH DOUBLE O-RINGS ensures maximum leak-proof performance manufactured with high-quality WRAS approved thicker material for strength and durability, are available in a transparent or blue sump, blue head with pressure relief (PR) valve and are made to store broad range of 2 1/2" x 9 7/8" diameter cartridges widely available on the market. Brass insert connections are available in 1/2", 3/4" and 1" female BSP ports.

AQUAFILTER AH-H10C SERIES FILTER HOUSINGS are WRAS certified for material and structural integrity and ideal for typical applications as point of entry (POE) pre and post-filtration as well point of use (POU) such under sink filter systems, ice machines, food service and other residential commercial and light industrial applications.

Filter Housing Set includes: Filter housing, FCPS5 sediment 5 micron cartridge, mounting bracket with screws, wrench, and bacteriostatic filter centralizing ring packed in color box.

SET



| part no. | size |
|------------|----------|
| FHPR12-HP1 | 1/2" BSP |
| FHPR34-HP1 | 3/4" BSP |
| FHPR1-HP1 | 1" BSP |

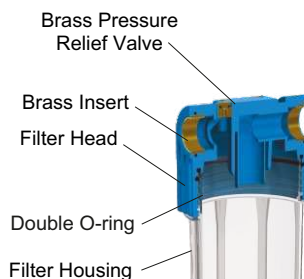

THREE PART FILTER HOUSINGS

AH-H051020 5", 10" AND 20" THREE PART FILTER HOUSINGS



MOLDED INSERT

AQUAFILTER AH-H051020 SERIES

THREE PART FILTER HOUSINGS manufactured with high-quality WRAS approved material, are available in a transparent or blue sump, blue head with pressure relief (PR) valve and are made to store broad range of 2 1/2" x 4 7/8", 9 7/8" and 20" diameter cartridges widely available on the market. Connections are available in 1/2", 3/4" and 1" female BSP ports.

AQUAFILTER AH-H051020 SERIES FILTER HOUSINGS are WRAS certified for material and structural integrity and ideal for typical applications as point of entry (POE) pre and post-filtration as well point of use (POU) such under sink filter systems, ice machines, food service and other residential commercial and light industrial applications.

Filter Housing Set includes: Mounting bracket with screws, wrench, bacteriostatic filter centralizing ring packed in color box.

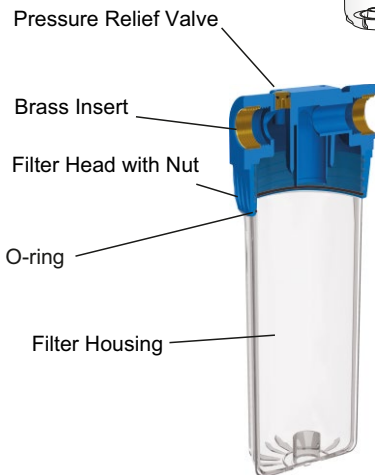
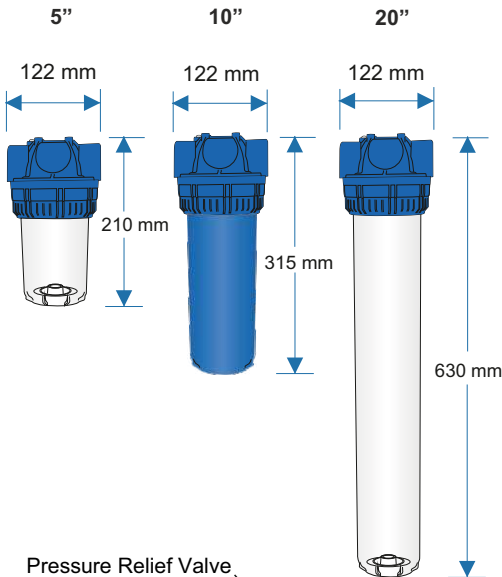

5 INCH

10 INCH

10 INCH SET

20 INCH

TRANSPARENT SUMP

BLUE SUMP

MOLDED INSERT



| part no. | size |
|--------------|----------|
| FHPL5-12-3BS | 1/2" BSP |
| FHPL5-34-3BS | 3/4" BSP |
| FHPL5-1-3BS | 1" BSP |

| part no. | size |
|---------------|----------|
| FHPLN5-12-3BS | 1/2" BSP |
| FHPLN5-34-3BS | 3/4" BSP |
| FHPLN5-1-3BS | 1" BSP |

MOLDED INSERT



| part no. | size |
|------------|----------|
| FHPL12-3BS | 1/2" BSP |
| FHPL34-3BS | 3/4" BSP |
| FHPL1-3BS | 1" BSP |

| part no. | size |
|-------------|----------|
| FHPLN12-3BS | 1/2" BSP |
| FHPLN34-3BS | 3/4" BSP |
| FHPLN1-3BS | 1" BSP |

MOLDED INSERT



| part no. | size |
|-----------|----------|
| FHPL12-3B | 1/2" BSP |
| FHPL34-3B | 3/4" BSP |
| FHPL1-3B | 1" BSP |

| part no. | size |
|------------|----------|
| FHPLN12-3B | 1/2" BSP |
| FHPLN34-3B | 3/4" BSP |
| FHPLN1-3B | 1" BSP |

MOLDED INSERT



| part no. | size |
|--------------|----------|
| FHPL12-3BS-L | 1/2" BSP |
| FHPL34-3BS-L | 3/4" BSP |
| FHPL1-3BS-L | 1" BSP |

| part no. | size |
|---------------|----------|
| FHPLN12-3BS-L | 1/2" BSP |
| FHPLN34-3BS-L | 3/4" BSP |
| FHPLN1-3BS-L | 1" BSP |

THREE PART FILTER HOUSINGS

AH-H051020 5", 10" AND 20" THREE PART FILTER HOUSINGS



BRASS INSERT

5 INCH

TRANSPARENT SUMP

BRASS INSERT



| part no. | size |
|--------------|----------|
| FHPR5-12-3BS | 1/2" BSP |
| FHPR5-34-3BS | 3/4" BSP |
| FHPR5-1-3BS | 1" BSP |

BLUE SUMP



| part no. | size |
|---------------|----------|
| FHPRN5-12-3BS | 1/2" BSP |
| FHPRN5-34-3BS | 3/4" BSP |
| FHPRN5-1-3BS | 1" BSP |

AQUAFILTER AH-H051020 SERIES

THREE PART FILTER HOUSINGS manufactured with high-quality WRAS approved material, are available in a transparent or blue sump, blue head with pressure relief (PR) valve and are made to store broad range of 2 1/2" x 4 7/8", 9 7/8" and 20" diameter cartridges widely available on the market. Brass insert connections are available in 1/2", 3/4" and 1" female BSP ports.

AQUAFILTER AH-H051020 SERIES FILTER HOUSINGS are WRAS certified for material and structural integrity and ideal for typical applications as point of entry (POE) pre and post-filtration as well point of use (POU) such under sink filter systems, ice machines, food service and other residential commercial and light industrial applications.

Filter Housing Set includes: Mounting bracket with screws, wrench, bacteriostatic filter centralizing ring packed in color box.

10 INCH



BRASS INSERT

| part no. | size |
|------------|----------|
| FHPR12-3BS | 1/2" BSP |
| FHPR34-3BS | 3/4" BSP |
| FHPR1-3BS | 1" BSP |



| part no. | size |
|-------------|----------|
| FHPRN12-3BS | 1/2" BSP |
| FHPRN34-3BS | 3/4" BSP |
| FHPRN1-3BS | 1" BSP |

10 INCH SET



BRASS INSERT

| part no. | size |
|-----------|----------|
| FHPR12-3B | 1/2" BSP |
| FHPR34-3B | 3/4" BSP |
| FHPR1-3B | 1" BSP |



| part no. | size |
|------------|----------|
| FHPRN12-3B | 1/2" BSP |
| FHPRN34-3B | 3/4" BSP |
| FHPRN1-3B | 1" BSP |

20 INCH



BRASS INSERT

| part no. | size |
|--------------|----------|
| FHPR12-3BS-L | 1/2" BSP |
| FHPR34-3BS-L | 3/4" BSP |
| FHPR1-3BS-L | 1" BSP |



| part no. | size |
|---------------|----------|
| FHPRN12-3BS-L | 1/2" BSP |
| FHPRN34-3BS-L | 3/4" BSP |
| FHPRN1-3BS-L | 1" BSP |



THREE PART FILTER HOUSINGS

AH-H05A 5" THREE PART SLIM FILTER HOUSINGS

AQUAFILTER AH-H05A SERIES

THREE PART FILTER HOUSINGS manufactured with high-quality WRAS approved material, are available in a transparent or blue sump, blue head with pressure relief (PR) valve and are made to store broad range of 2 1/2" x 4 7/8" diameter cartridges widely available on the market. Brass insert connections are available in 1/2", 3/4" and 1" female BSP ports.

AQUAFILTER AH-H05A SERIES FILTER HOUSINGS are WRAS certified for material and structural integrity and ideal for typical applications as point of entry (POE) pre and post-filtration as well point of use (POU) such under sink filter systems, ice machines, food service and other residential commercial and light industrial applications.

Filter Housing Set includes: Filter housing, mounting bracket with screws, and wrench, packed in color box.

SINGLE



SET



| part no. | size | part no. | size |
|----------|----------|-------------|----------|
| FHPR5-12 | 1/2" BSP | FHPR5-12-WB | 1/2" BSP |
| FHPR5-34 | 3/4" BSP | FHPR5-34-WB | 3/4" BSP |
| FHPR5-1 | 1" BSP | FHPR5-1-WB | 1" BSP |

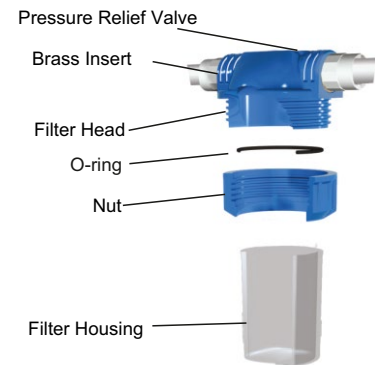
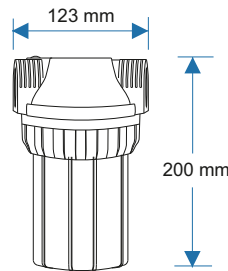

AH-H10G 10" THREE PART SLIM LINE FILTER HOUSINGS

AQUAFILTER AH-H10G SERIES

THREE PART FILTER HOUSINGS manufactured with high-quality WRAS approved material, are available in a transparent or blue sump, blue head with pressure relief (PR) valve and are made to store broad range of 2 1/2" x 9 7/8" diameter cartridges widely available on the market. Brass insert connections are available in 1/2", 3/4" and 1" female BSP ports.

The green sump and green head are made from special bacteriostatic and UV protection materials for special applications.

AQUAFILTER AH-H10G SERIES FILTER HOUSINGS are WRAS certified for material and structural integrity and ideal for typical applications as point of entry (POE) pre and post-filtration as well point of use (POU) such under sink filter systems, ice machines, food service and other residential commercial and light industrial applications.

Filter Housing Set includes: Filter housing, mounting bracket with screws and wrench packed in color box.

SINGLE



SET



| part no. | size | part no. | size |
|-----------|----------|------------|----------|
| FHPR12-3S | 1/2" BSP | FHPR12-3_R | 1/2" BSP |
| FHPR34-3S | 3/4" BSP | FHPR34-3_R | 3/4" BSP |
| FHPR1-3S | 1" BSP | FHPR1-3_R | 1" BSP |

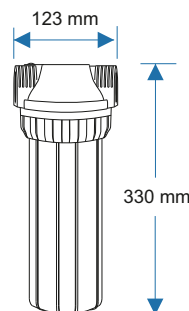

SET



| part no. | size |
|---------------|----------|
| FHPR34-3_R-AB | 3/4" BSP |
| FHPR1-3_R-AB | 1" BSP |

THREE PART SPIN-DOWN FILTER HOUSINGS

AH-H10G 10" THREE PART SPIN-DOWN FILTER HOUSINGS

AQUAFILTER AH-H10G SERIES

THREE PART SPIN-DOWN FILTER HOUSINGS are equipped with a drain valve enabling flushing sediments from the housing without removing filter cartridge (applicable with multi-use cartridges FCPNN series). Manufactured with high-quality WRAS approved material, are available in a transparent sump, blue head with pressure relief (PR) valve and are made to store special range of 2 1/2" x 9 7/8" diameter FCPNN. Brass insert connections in 1/2", 3/4" and 1" female BSP ports.

The green sump and green head are made from special bacteriostatic and UV protection materials for special applications.

AQUAFILTER AH-H10G SERIES FILTER HOUSINGS are WRAS certified for material and structural integrity and ideal for typical applications as point of entry (POE) pre filtration systems, food service and other residential commercial and light industrial applications.

Filter Housing Set includes: Filter housing, mounting bracket with screws and wrench packed in color box.

HOW SPIN-DOWN FILTER WORKS



Water enters from the top of a spin-down filter and spins in a centrifugal motion. The design of the head diverts water so it circulates the water through the filter housing, this forces the dirt and debris to be pushed to the outside of the clear housing and will settle in the bottom. To release all of that dirt and debris from the housing, you must periodically open the valve.



Multi-use single open end sediment filter cartridges (nylon mesh) for cold water

| Part no. | Size |
|-----------|----------|
| FCPNN50M | 50 mic. |
| FCPNN100M | 100 mic. |
| FCPNN150M | 150 mic. |

SINGLE



| part no. | size |
|------------|----------|
| FHPR12-3VS | 1/2" BSP |
| FHPR34-3VS | 3/4" BSP |
| FHPR1-3VS | 1" BSP |

SET



| part no. | size |
|-------------|----------|
| FHPR12-3V_R | 1/2" BSP |
| FHPR34-3V_R | 3/4" BSP |
| FHPR1-3V_R | 1" BSP |

SET



| part no. | size |
|----------------|----------|
| FHPR34-3V_R-AB | 3/4" BSP |
| FHPR1-3V_R-AB | 1" BSP |

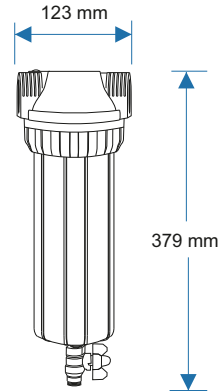

THREE PART SPIN-DOWN FILTER HOUSINGS

AH-H3SLV THREE PART SPIN-DOWN FILTER HOUSINGS

AQUAFILTER AH-H3SLV SERIES
THREE PART SPECIAL SPIN-DOWN FILTER HOUSINGS are equipped with a drain valve enabling flushing sediments from the housing without removing special multi-use filter cartridge. Manufactured with high-quality WRAS approved material, are available in a transparent sump, blue head with brass insert connections in 1/2" female BSP port.

AQUAFILTER AH-H3SLV SERIES FILTER HOUSINGS are WRAS certified for material and structural integrity and ideal for typical applications as point of entry (POE) pre filtration systems, food service, antiscaling protection and other residential commercial and light industrial applications.

Filter housing fits standard mounting bracket.



Filter for polyphosphate dosing to increase the capacity to transform limestone and protect equipment and installations. Protects the equipment against scale and fouling, improving heating efficiency and significantly reducing energy consumption.



Filter for polyphosphate dosing to increase the capacity to transform limestone and protect equipment and installations. Protects the equipment against scale and fouling, improving heating efficiency and significantly reducing energy consumption. Equipped with drain valve, to discharge dirt, all you need to do is open the ball valve drain at the bottom of the filter.



The filter is designed to filter water at the point of entry into the system. It features a current-flow washing system that greatly facilitates cleaning of the filter cartridge. To discharge dirt, all you need to do is open the ball valve drain at the bottom of the filter.



Filter for polyphosphate dosing to increase the capacity to transform limestone and protect equipment and installations. Protects the equipment against scale and fouling, improving heating efficiency and significantly reducing energy consumption.



Filter for polyphosphate dosing to increase the capacity to transform limestone and protect equipment and installations. Protects the equipment against scale and fouling, improving heating efficiency and significantly reducing energy consumption. Equipped with drain valve, to discharge dirt, all you need to do is open the ball valve drain at the bottom of the filter.

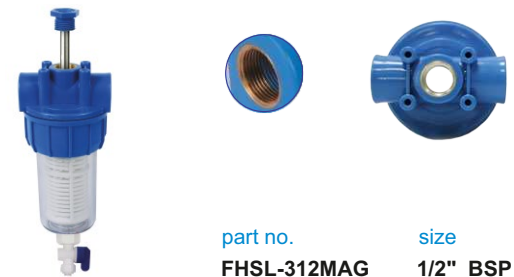

Magnetic Filter eliminates ferrous debris from the fluids, enters through the flow passage between the magnet and the clean fluid exits through the discharge port of the housing, with very low pressure drop.

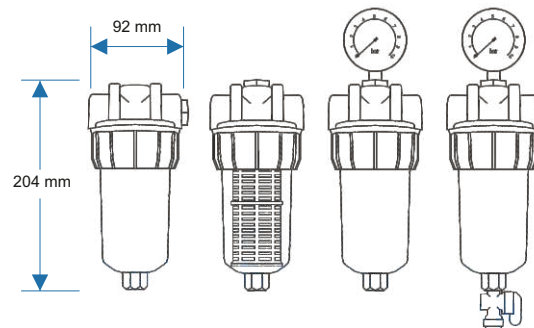

SPECIAL FILTER HOUSINGS

AH-H105 10" HIGH TEMPERATURE FILTER HOUSINGS



| part no. | size |
|------------|----------|
| FHHOT12-WB | 1/2" BSP |
| FHHOT34-WB | 3/4" BSP |

AQUAFILTER AH-H105 SERIES

TWO PART HIGH TEMPERATURE FILTER HOUSINGS WITH DOUBLE O-RINGS ensures maximum leak-proof performance manufactured with high-quality special thicker material for high temperature resistance, are available in a gray sump, gray head with pressure relief (PR) valve and are made to store special FCPHH range of 2 1/2" x 9 7/8" diameter cartridges. Brass insert connections in 1/2" and 3/4" female BSP ports.

AQUAFILTER AH-H105 SERIES FILTER HOUSINGS are ideal ideal for high temperature use and many other applications like sea water, organic solvents, alcohol and vegetable oils, other residential commercial and light industrial applications. Economical alternative to stainless steel housings.

Filter Housing Set includes: Filter housing, mounting bracket with screws, wrench, packed in color box.



Multi-use single open end sediment filter cartridges (nylon mesh) for cold water

| Part no. | Size |
|-----------|----------|
| FCPHH50M | 50 mic. |
| FCPHH100M | 100 mic. |
| FCPHH150M | 150 mic. |

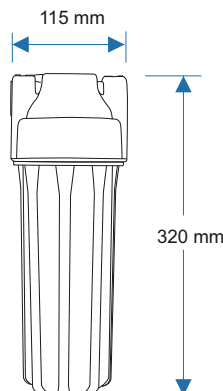

AH-HSH1 BRASS SEDIMENT FILTER

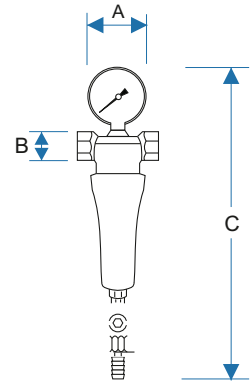

| part no. | size |
|----------|----------|
| FHMB12 | 1/2" BSP |
| FHMB34 | 3/4" BSP |
| FHMB1 | 1" BSP |

Brass, nickel-coated sediment filter, stainless steel screen cartridge of 100 µm; pressure gauge and drain valve.

| | FHMB12 | FHMB34 | FHMB1 |
|---|---------------|---------------|---------------|
| A | 56 (+/-3) mm | 63 (+/-3) mm | 73 (+/-3) mm |
| B | 1/2" BSP | 3/4" BSP | 1" BSP |
| C | 283 (+/-3) mm | 283 (+/-3) mm | 286 (+/-3) mm |

AH-HM20 RO MEMBRANE HOUSINGS

AQUAFILTER AH-HM20 SERIES MEMBRANE HOUSINGS are manufactured with high-quality WRAS approved thicker material for strength and durability with dual O-rings. The housing will accommodate most standard residential membrane elements, available in white color, for use in Reverse Osmosis Water Treatment Systems.



| part no. | size | part no. | size |
|----------|------------|------------|--------------------------|
| YT-25W | 3x1/8" NPT | YT-3-3814W | 1x3/8" NPT 2x1/8" NPT |

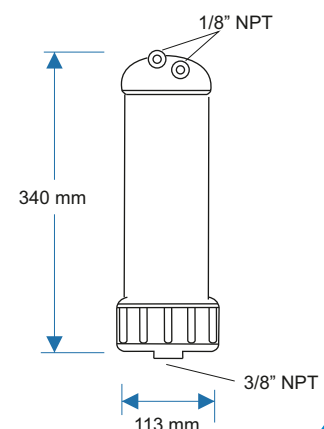
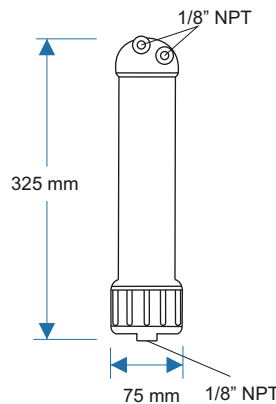

BIG BLUE FILTER HOUSINGS

Big Blue filter housings offer the versatility to meet all of your large capacity filtration needs, including high-flow and heavy-sediment applications. The extra large housing allows for greater cartridge capacity, reducing the number of vessels required for high flow-rate applications. Sumps are constructed of durable polypropylene and are available in both 10" and 20" lengths.

The high-flow polypropylene cap are available with 1", 1 1/4" and 1 1/2" molded insert inlet and outlet ports.

Big Blue housings are compatible with a broad range of chemicals and are available with pressure-relief button, plastic mounting bracket with screws, wrench, pressure gauge, nickel extension to the pressure gauge, bacteriostatic filter centralizing ring.

They accept a wide variety of 4 1/2" diameter cartridges in either 10" or 20" lengths.

Features:

- High quality
- WRAS certificate
- FDA CFR Title 21 Compliance
- Competitive Pricing
- Factory Tested
- Domestic and commercial use
- Large capacity housing suitable for high flow applications
- Pressure relief valve on inlet and outlet of filter head
- Ideal for POE use
- Easy to connect to cold water inlet
- Full flow 1", 1 1/4", 1 1/2" ports
- Made in EU with High Performance Components

AH-HB1D 10" BIG BLUE



| part no. | size |
|-----------|------------|
| FH10B1_M | 1" BSP |
| FH10B54_M | 1 1/4" BSP |
| FH10B64_M | 1 1/2" BSP |

10" Big Blue filter housings BSP inlet/outlet equipt with two pressure relief valves. For cold water. Made in the EU.

| part no. | size |
|------------|------------|
| FH10B1-WB | 1" BSP |
| FH10B54-WB | 1 1/4" BSP |
| FH10B64-WB | 1 1/2" BSP |

10" Big Blue filter housings BSP inlet/outlet equipt with two pressure relief valves, mounting bracket with screws, wrench, bacteriostatic filter centralizing ring, color box. For cold water. Made in the EU

AH-HB2D 20" BIG BLUE



| part no. | size |
|-----------|------------|
| FH20B1_L | 1" BSP |
| FH20B54_L | 1 1/4" BSP |
| FH20B64_L | 1 1/2" BSP |

| part no. | size |
|------------|------------|
| FH20B1-WB | 1" BSP |
| FH20B54-WB | 1 1/4" BSP |
| FH20B64-WB | 1 1/2" BSP |

10" BIG BLUE



20" BIG BLUE

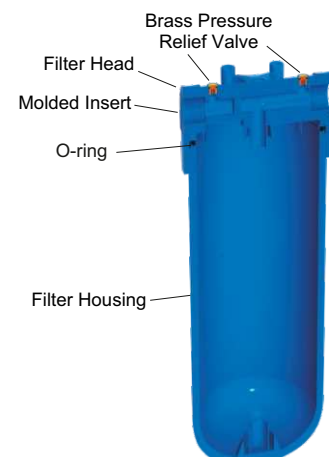

BIG BLUE FILTER HOUSINGS WITH BRASS INSERTS

Big Blue filter housings offer the versatility to meet all of your large capacity filtration needs, including high-flow and heavy-sediment applications. The extra large housing allows for greater cartridge capacity, reducing the number of vessels required for high flow-rate applications. Sumps are constructed of durable polypropylene and are available in both 10" and 20" lengths. They accept a wide variety of 41/2" diameter cartridges in either 10" or 20" lengths.

The high-flow polypropylene cap are available with 1", 1 1/4", 1 1/2" brass insert inlet and outlet ports with two pressure relief valves. Big Blue housings are compatible with a broad range of chemicals and are equip with pressure-relief button, plastic mounting bracket with screws, wrench, pressure gauge, nickel extension to the pressure gauge, bacteriostatic filter centralizing ring.

Features:

- High quality
- WRAS certificate
- FDA CFR Title 21 Compliance
- Competitive Pricing
- Factory Tested
- Domestic and commercial use
- Large capacity housing suitable for high flow applications
- Pressure relief valve on inlet and outlet of filter head
- Ideal for POE use
- Easy to connect to cold water inlet
- Full flow 1", 1 1/4", 1 1/2" ports
- Made in EU with High Performance Components

Set includes: Big Blue type filter housing, plastic mounting bracket with screws, wrench, pressure gauge, nickel extension to the pressure gauge, bacteriostatic filter centralizing ring packed in color box.

AH-HB1B 10" BIG BLUE



part no. **FH10B1_B** size **1" BSP**

10" Big Blue filter housings BSP brass inlet/outlet equip with two pressure relief valves packed in color box.



part no. **FH10B1-B-WB** size **1" BSP**

10" Big Blue filter housings BSP brass inlet/outlet equip with two pressure relief valves, pressure gauge, nickel extension to the pressure gauge, mounting bracket with screws, wrench, bacteriostatic filter centralizing ring packed in color box.

AH-HB2B 20" BIG BLUE



part no. **FH20B1_B** size **1" BSP**

20" Big Blue filter housings with brass BSP inlet/outlet equip with two pressure relief valves packed in color box.



part no. **FH20B1-B-WB** size **1" BSP**

20" Big Blue filter housings with brass BSP inlet/outlet equip with two pressure relief valves, pressure gauge, nickel extension to the pressure gauge, mounting bracket with screws, wrench, bacteriostatic filter centralizing ring, packed in color box.

20" BIG BLUE

10" BIG BLUE

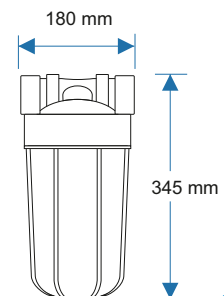
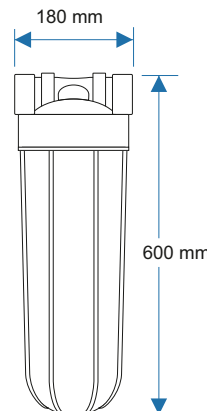
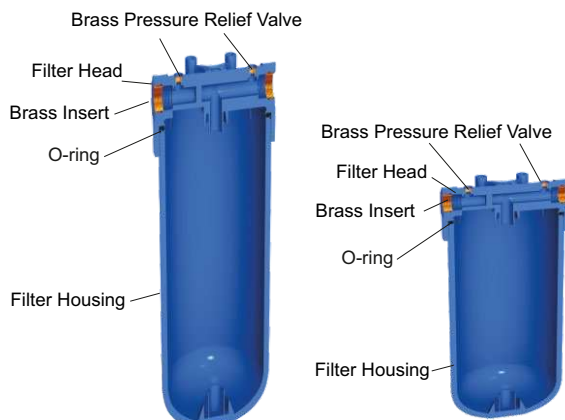

SUPER SLIM TWO PART FILTER HOUSINGS

AH-SLIM TWO PART SUPER SLIM FILTER HOUSINGS



EKOPF4-SLIM1

EKOPF4-SLIM2

EKOPF4-SLIM3

EKOPF4-SLIM4

Super Slim filter housing with white or transparent sump, white cap, 1/4 female QF. Working with a wide range of UDF-SL cartridges.

Super Slim filter housing with transparent or black sump, black cap, 1/4 female QF. Working with a wide range of UDF-SL cartridges.

General Description:

AH-SLIM Filter Housing. Economical and low cost Push-in cartridge water filtration system. This new, clear filter housing is specially designed for multiple uses. Ideal for domestic family homes, it conveniently fits under the kitchen sink and effectively contains the desired cartridge.

Features:

- High quality
- Competitive pricing
- Domestic and commercial use
- Works in water coolers and other applications
- Additional equipment - filter bracket and cover
- Filter housing is equipped with quick connectors 1/4"
- Super strong filter housing
- Multi-use option
- Low cost maintenance
- Easy to install
- Compact size for any kitchen under counter cabinets and any other application
- Made in the EU



AH-SLIM

| | CATALOG NUMBER | DESCRIPTION |
|--|----------------|--|
| | FCPS5-SL | Sediment Pre-Filter Melt-blown polypropylene |
| | FCCBL-SL | Carbon Cartridge Pre-Filter Extruded activated carbon with other treatment media |
| | FCCM-SL | Post-Carbon Filter-Antibacterial Mineralization 3 in one Coconut shell activated carbon Re-Mineralization Filter Cartridge Antibacterial/Antimicrobial protection |
| | FCCST2-SL | Ion exchange 2 in one High quality ion exchange resin |
| | TLCHF-SL | Ultrafiltration membrane (UF) Ultrafiltration separation mechanism is commonly attributed to the pore size of the membrane as low as 0,01 micron . |
| | FCCFE-SL | Iron reduction High quality media |
| | FCCBHD-SL | UDF Coconut Shell Carbon Coconut shell activated carbon |
| | FCCST-SL | Ion exchange High quality ion exchange resin |
| | FCCKDF-SL | UDF Coconut Shell Carbon Coconut shell activated carbon with KDF |
| | FCPS-AB-SL | Sediment Antibacterial Nanosilver technology |



SALES@AQUAFILTER.COM



DISTRIBUTOR

more info



ALL AQUAFILTER IMAGES, TRADEMARKS, LOGOS AND OTHER INTELLECTUAL PROPERTY ARE THE SOLE AND EXCLUSIVE PROPERTY OF AQUAFILTER INC. AND MAY NOT BE USED WITHOUT OUR EXPRESS WRITTEN PERMISSION.



Made in EU



AQUAFILTER EUROPE

UL. ŚW. TERESY 101
91-222 ŁÓDŹ, POLAND

WWW.AQUAFILTER.COM



AQUAFILTER GERMANY



AQUAFILTER BELARUS

ADVANTA SYSTEM,
KRASNOGARDEYSKAYA
114B/5 224024 BREST,
BELARUS



Management System
ISO 9001:2015
ISO 14001:2015
www.tuv.com
ID 9105076259





MADE IN EU

AC



AA



AH



AS AE AU AR







AS,AE,AU,AR CATALOG

WWW.AQUAFILTER.COM

SYSTEMS

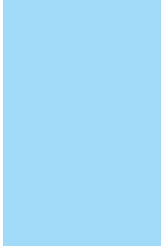

TABLE OF CONTENTS

| | | |
|---|---|----------|
|  | AS - BATHROOM FILTERS | 1 |
| | AS-SHO - SHOWER FILTERS | 1 |
| | AS-WMF - WASHING MACHINE FILTERS | 1 |
|  | AU - POINT OF USE FILTERS | 2 |
| | AE-FOU - FAUCET FILTERS | 2 |
| | AE-FUF - OPEN TYPE ULTRAFILTRATION SYSTEMS | 2 |
| | AE-FUCS - UNDERCOUNTER SYSTEMS | 2 |
| | AE-FCTS - COUNTER-TOP FILTERS | 3 |
| | AE-FUCC, FUFC - COVER TYPE SYSTEMS (EXCITO) | 3 |
|  | AE - POINT OF ENTRY FILTERS | 4 |
| | AE-PLB - WHOLE HOUSE SYSTEMS | 4 |
| | AE-HHB - BIG BLUE WHOLE HOUSE SYSTEMS | 5 |
|  | AR - RO SYSTEMS | 6 |
| | AR-REG - RO SYSTEMS WITHOUT PUMPS | 6 |
| | AR-WPU - RO SYSTEMS WITH PUMPS | 7 |
| | AR-CAS - RO SYSTEMS IN CASES | 7 |
| | AR-AQU - OTHER RO SYSTEMS | 7 |
| | AR-ELITE - RO ELITE | 8 |
|  | AD - DWETS | 9 |

AS



AS BATHROOM FILTERS



AS BATHROOM FILTERS

Natural river and ground waters contain various salts, mainly bicarbonates, chlorides and sulphates. The presence of salt causes the hardness of water, which is disadvantageous for the human body and makes foaming soap and other detergents more difficult. Using our filters you can get rid of harmful substances and bacteria from the water, improve the quality of the bath and the more efficient use of washing machines or dishwashers.

SHOWER FILTERS

Filters filled with quartz bed and KDF-55 deposit - removes chlorine (up to 99%), heavy metals (mercury, lead, etc.) and suspensions. Prevents the growth of bacteria. Systematic use of the filter provides the necessary protection for the skin, hair and lungs against the influence of harmful chlorine and heavy metals.

Benefits of using:

- relief for dry skin and irritated eyes
- healthier and younger-looking skin
- smoother and easier to apply hair
- protection of the lungs, mucous membranes and tissues
- eliminates bad smell

WASHING MACHINE FILTERS

The washing machine and dishwasher filters protect household appliances against scaling, which accumulates on the elements of household appliances (drums, heaters, etc.), destroy equipment and increase energy consumption. The filter increases the efficiency of detergents up to 30%.



BATHROOM FILTERS



AS-SHO SHOWER FILTERS



FHSH-8-C

Hand-Held Shower Filter with cartridge, handle type 8 (regular shower disc). **New style** convenient hand-held design and 99% chlorine reduction. Restores natural softness to hair, scalp and skin. Filter connection 1/2" FIP. Set includes: Shower filter, cartridge, accessories.



FHSH-5-C

Hand-Held Shower Filter with cartridge, chrome handle type 5 (regular shower disc), with three different shower massage functions. Convenient hand-held design and 99% chlorine reduction. Restores natural softness to hair, scalp and skin. Filter head dimensions: 10,5 cm, 1/2" FIP. Restores natural softness to hair, scalp and skin.



FCSH-56_K

Set of 2 filtration cartridges with KDF and ceramic media for hand-held shower filter series: FHSH-5-C, FHSH-6-C and FHSH-8-C. Set includes: 2 x cartridge.



FHSH-1

FCSH-1

Experience a refreshing showering with AQUAFILTERS barrel type multi-stage Shower filter with GAC and KDF media. The unique shower filter is engineered to reduce a broad Spectrum of contaminants, Restores natural softness to hair, scalp and skin. Set includes: Shower filter and cartridge.

AS-WMF

WASHING MACHINE FILTERS



FHSB

Bath ball filter for quick chlorine removal. Filter media: KDF filament & Crystal Quartz. No plumbing or fittings required.



FHPRA

Water anti-scale washing machine filter 3/4" Male x 3/4" Female (BSP) with brass insert.



FHPRA-P

Water anti-scale washing machine filter 3/4" Male x 3/4" Female (BSP) plastic insert.



FHPRA-R

Replacement polyphosphate for filter FHPRA - (250 gram).



FHSH-8-C



FHSB



FHPRA



FHSH-1

- SEDIMENT REMOVAL
- CHLORINE REMOVAL
- BACTERIOSTATIC
- HEAVY METAL REMOVAL
- ANTISCALE
- ODOR

| | | | | |
|---------------------|---|---|---|---|
| SEDIMENT REMOVAL | ● | | | ● |
| CHLORINE REMOVAL | ● | ● | | ● |
| BACTERIOSTATIC | ● | | | |
| HEAVY METAL REMOVAL | ● | ● | | ● |
| ANTISCALE | | | ● | |
| ODOR | | | | ● |

AU



AU POINT-OF-USE

AU POINT-OF-USE

A Point-of-Use water filter is a type of water filtration system that treats the water at a single tap. These types of filters are most commonly installed under a kitchen sink in order to provide high-quality, clean and healthy drinking water at the kitchen tap. Unlike whole house water filtration systems, which treat water as soon as it enters your home, Point-of-Use water filters treat water right before it reaches the single tap that it is connected to.

| | |
|---|----------|
| AU-FOU - FAUCET FILTERS | 2 |
| AU-FUF - OPEN-TYPE ULTRAFILTRATION SYSTEMS | 2 |
| AU-FUCS - UNDERCOUNTER SYSTEMS | 2 |
| AU-FCTS - COUNTER-TOP FILTERS | 3 |
| AU-FUFC - COVER TYPE ULTRAFILTRATION SYSTEMS | 3 |
| AU-FUCC - COVER TYPE SYSTEMS | 3 |



POINT-OF-USE FILTERS



AU-FOU FAUCET FILTERS



FH2018-1-AQ

FH2018-1-AQ : Faucet filter with coconut shell carbon cartridge complete set.

FH2018-2-AQ: Faucet filter with ultrafiltration membrane (UF) and coconut shell carbon cartridge complete set.

FH2018-2-AQ



FC2018-1-AQ

FC2018-1-AQ: Carbon cartridge for faucet FH2018-1-AQ or FH2018-2-AQ.



FC2018-2-AQ

FC2018-2-AQ: Carbon and ultrafiltration (UF) cartridge for faucet FH2018-1-AQ or FH2018-2-AQ.

AU-FUCS UNDERCOUNTER SYSTEMS



FP2-W-K1

2-stage economical undercounter filtration system, made of WRAS certified components. Package contains: 1 stage transparent sump with sediment 5 micron cartridge (FCPS5), second stage white sump with carbon block (FCCBL) cartridge, wrench, chrome faucet, 1/2" feed water connector, tubing and other accessories for easy and quick installation.



FP3-K1N

3 stage undercounter water filtration system suitable for POU (Point of Use) installations. Through an accurate combination of pre-filtration, softening and activated carbon with special media treatments it ensures you a continuous supply of fresh and clean drinking water. Includes: 5 micron-rating Sediment filter FCPS5 (Stage 1) Softening cartridge FCCST2 (Stage 2) Granular Activated Carbon with KDF media cartridge FCCBKDF (Stage 3) Set include all accessories for easy and quick installation.

AU-FUF OPEN TYPE ULTRAFILTRATION SYSTEMS



FP3-HJ-K1N

4 stage undercounter water filtration systems with (UF) ultrafiltration membrane, made of WRAS certified components.

Package contains:

Cartridges:

- First stage transparent sump with sediment 5 micron cartridge (FCPS5)
- Second stage white sump with special softening cartridge (FCCST2)
- Third stage white sump with (GAC) granulated coconut shell carbon mix with KDF media (FCCBKDF) cartridge
- Fourth stage (UF) ultrafiltration membrane (TLCHF-2T) in 2" transparent in-line housing

Accessories:

- Wrench
- Long reach chrome faucet
- 1/2" feed water connector with valve and tubing
- ...and other accessories for easy and quick installation



FP3-K1N



FP3-HJ-K1N



FP2-W-K1



FH2018-x-AQ

| | | | |
|---|---|---|---|
| ● | ● | ● | ● |
| ● | ● | ● | ● |
| | ● | | ● |
| ● | ● | | |
| ● | ● | | |
| ● | ● | ● | ● |
| ● | ● | | ● |

- SEDIMENT REMOVAL
- CHLORINE REMOVAL
- BACTERIA REMOVAL
- HEAVY METAL REMOVAL
- WATER HARDNESS REDUCER
- TASTE & ODOR
- ANTISCALE

POINT-OF-USE FILTERS

AU-FCTS COUNTER-TOP FILTERS



FHCTF

Single transparent housing countertop water filter with 2 stage filtration, made of WRAS certified filter housing and components. **Package contains:** FCCA-STO cartridge 2 in one (sediment and activated carbon cartridge), faucet, water connector to faucet, tubing, color box.



FHCTF2

2 stage two filter housings countertop water filter, made of WRAS certified components. **Package contains:** first stage sediment cartridge 20 micron (FCPS20) and second stage carbon block cartridge (FCCBL), faucet, water connector to faucet, tubing, color box.

AU-FUFC COVER TYPE ULTRAFILTRATION SYSTEMS



EXCITO-WAVE

4 stage (UF) ultrafiltration systems based on "TWIST" cartridge type. **Package contains:** cartridges AIPRO-1M-TW, AISTRO-2-TW, FCCBL-S-TW, TLCHF-TW, (for more specific cartridge information please check the cartridge section) FXFCH17-C long reach chrome faucet, 1/2" feed water connector tubing and other accessories for easy and quick installation.

AU-FUCC COVER TYPE SYSTEMS



EXCITO-ST

4 stage water filtration system in compact slim case. **Package contains:** cartridges AIPRO-20M-AQ, AISTRO-L-AQ, AICRO-L4-AQ, AIPRO-1M-AQ (for more specific cartridge information please check the cartridge section), FXFCH17-C long reach chrome faucet, 1/2" feed water connector tubing and other accessories for easy and quick installation.



EXCITO-CL

Alkaline 5 stage water filtration systems in compact slim case, uses Nanosilver Technology with transparent filtration in-line type cartridges. **Package contains:** cartridges AIPRO-1M-CL, AISTRO-L-CL, FCCBL-S-CL, AIFIR-250, AICRO-AB, FXFCH17-C long reach chrome faucet, 1/2" feed water connector tubing and other accessories.



EXCITO-B

5 stage (UF) ultrafiltration systems system in compact slim case base on Quick Male connector cartridge type. **Package contains:** cartridges AIPRO-20M-QM, AISTRO-2-QM, AICRO-3-QM, AICRO-4-QM, TLCHF-2T, FXFCH17-C long reach chrome faucet, 1/2" feed water connector tubing and other accessories for easy and quick installation.



FHCTF



FHCTF2



EXCITO-WAVE



EXCITO-B



EXCITO-CL



EXCITO-ST

| | | | | | | |
|-----------------------|---|---|---|---|---|---|
| SEDIMENT REMOVAL | ● | ● | ● | ● | ● | ● |
| CHLORINE REMOVAL | ● | ● | ● | ● | ● | ● |
| BACTERIA REMOVAL | | | ● | ● | | |
| HEAVY METAL REMOVAL | | | ● | ● | ● | ● |
| WATER HARDNESS /SCALE | | | ● | | | ● |
| PH ADJUSTMENT | | | | ● | ● | |
| ALKALINE | | | | | ● | |

AE



AE
POINT-OF-ENTRY

AE POINT-OF-ENTRY

Point-of-Entry systems are professional devices (POE) providing clean water to the whole house installation. Depending on the type of cartridge used, they can act as a softening or deironing system. In our offer you can find two or three-stage systems based on traditional 10-inch housings or high-performance systems based on 10 or 20-inch Big Blue® housings. The systems can optionally be equipped with, for example, BY-PASS systems or pressure gauges.

| | |
|---|----------|
| AE-PLB - PLUMB-IN WATER FILTRATION SYSTEMS | 4 |
| AE-HHB - BIG BLUE WHOLE HOUSE SYSTEMS | 5 |





POINT-OF-ENTRY FILTERS



AE-PLB WHOLE HOUSE SYSTEMS



part no. **FHPRN12-B-TWIN** size **1/2" BSP**
FHPRN34-B-TWIN size **3/4" BSP**



part no. **FHPRN12-B-TRIPLE** size **1/2" BSP**
FHPRN34-B-TRIPLE size **3/4" BSP**

BRASS INSERTS



10" two or three stage system with blue filter sump and blue heads with inlet and outlet BSP brass inserts. **Set includes:** filtration system base on WRAS approved filter housing; and wrench, bacteriostatic filter centralizing ring and color box.



part no. **FHPRCL12-B-TWIN** size **1/2" BSP**
FHPRCL34-B-TWIN size **3/4" BSP**



part no. **FHPRCL12-B-TRIPLE** size **1/2" BSP**
FHPRCL34-B-TRIPLE size **3/4" BSP**

10" two or three stage system with transparent filter sump and blue heads with inlet and outlet BSP brass inserts. **Set includes:** filtration system base on WRAS approved filter housing; and wrench, bacteriostatic filter centralizing ring and color box.

WHOLE HOUSE SYSTEMS



part no. **FHPLN14-D-TWIN** size **1/4" NPT**
FHPLN12-D-TWIN size **1/2" BSP**
FHPLN34-D-TWIN size **3/4" BSP**



part no. **FHPLN14-D-TRIPLE** size **1/4" NPT**
FHPLN12-D-TRIPLE size **1/2" BSP**
FHPLN34-D-TRIPLE size **3/4" BSP**

MOLDED INSERTS



10" two or three stage system with blue filter sump and blue heads with inlet and outlet BSP inserts. **Set includes:** filtration system base on WRAS approved filter housing; and wrench, bacteriostatic filter centralizing ring and color box.



part no. **FHPLCL14-D-TWIN** size **1/4" NPT**
FHPLCL12-D-TWIN size **1/2" BSP**
FHPLCL34-D-TWIN size **3/4" BSP**



part no. **FHPLCL14-D-TRIPLE** size **1/4" NPT**
FHPLCL12-D-TRIPLE size **1/2" BSP**
FHPLCL34-D-TRIPLE size **3/4" BSP**

10" two or three stage system with transparent filter sump and blue heads with inlet and outlet BSP inserts. **Set includes:** filtration system base on WRAS approved filter housing; and wrench, bacteriostatic filter centralizing ring and color box.

POINT-OF-ENTRY FILTERS

Whole House Water Solutions

Aquafilter Whole House Filtration System provides a complete solution for your water applications.



**BIG BLUE
WHOLE HOUSE SYSTEMS**

AE-HHB BIG BLUE WHOLE HOUSE SYSTEMS

Benefits:

- 10" & 20"BB Filtration systems
- Quality drinking water
- Protect home appliances
- Healthier pets and plants
- Low maintenance system
- Chlorine and odor free showers

System Components

Pressure Release Valve

Molded in brass insert for pressure release in the filter housing is used for easier cartridge replacement. The valves are installed in the inlet and outlet side of the filter housing cap.



Inlet and Outlet

Molded 1" brass insert for leak proof heavy duty connection. The brass inserts are installed on both sides of housing cap.



Brass Extension for Pressure Gauge

For easy installation. The pressure release valve located in the filter housing is used for easier gauge display above the metal frame.



Pressure Gauges

This easy to use water pressure test gauges a maximum pressure of 11 bar easily, and determines the incoming water pressure from main water source and cartridge to cartridge. Additionally, pressure drop can be monitored through the two pressure gauges.

Filter Housing Wrench

Filter housing canister wrench fits all Aquafilter type of Big Blue housings.



Metal Frame

Powder coated heavy duty connection steel frame for easy system installation.

Antibacterial Filter Cartridge Centralizing Rings

This product centralizes the filter cartridge inside its housing and reduces the risk of damage to the cartridge and housing elements at installation.



part no. size
HHBB10A | 1" BSP

10" whole house Big Blue water filtration systems, made of WRAS certified components. **Set includes:** 2 x 10" Big Blue type filter housing with brass inserts, 2 x pressure gauge, metal platform, wrench, bacteriostatic filter cartridge centralizing rings.



part no. size
HHBB20A | 1" BSP

20" whole house Big Blue water filtration systems, made of WRAS certified components. **Set includes:** 2 x 20" Big Blue type filter housing with brass inserts, 2 x pressure gauge, metal platform, wrench, bacteriostatic filter cartridge centralizing rings.

System Installation

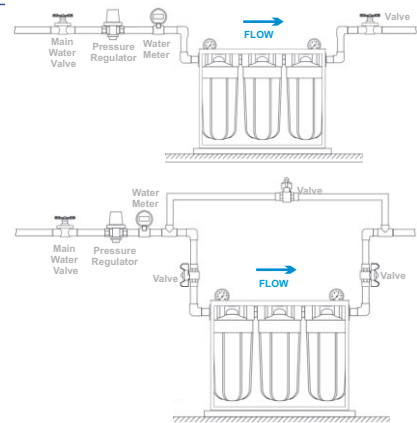

part no. size
HHBB10B | 1" BSP

10" whole house Big Blue water filtration systems, made of WRAS certified components. **Set includes:** 3 x 10" Big Blue type filter housing with brass inserts, 2 x pressure gauge, metal platform, wrench, bacteriostatic filter cartridge centralizing rings.



part no. size
HHBB20B | 1" BSP

20" whole house Big Blue water filtration systems, made of WRAS certified components. **Set includes:** 3 x 20" Big Blue type filter housing with brass inserts, 2 x pressure gauge, metal platform, wrench, bacteriostatic filter cartridge centralizing rings.

WARNING!
To seal threaded connection use only Teflon tape. Do not use it with cone-shaped (tapered) connections type.

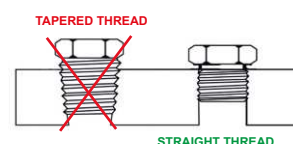

AR



AR
RO SYSTEMS

AR RO SYSTEMS

Reverse osmosis (RO) is a water purification technology that uses a partially permeable membrane to remove ions, molecules and larger particles from drinking water. In reverse osmosis, an applied pressure is used to overcome osmotic pressure, a colligative property, that is driven by chemical potential differences of the solvent, a thermodynamic parameter. Reverse osmosis can remove many types of dissolved and suspended chemical species as well as biological ones (principally bacteria) from water, and is used in both industrial processes and the production of potable water.

| | |
|--|----------|
| AR-REG - RO SYSTEMS WITHOUT PUMPS | 6 |
| AR-WPU- RO SYSTEMS WITH PUMPS | 7 |
| AR-AQU - RO SYSTEMS IN CASES | 7 |
| AR-CAS - OTHER RO SYSTEMS | 7 |
| AR-ELITE - RO ELITE SYSTEM | 8 |



RO SYSTEMS



AR-REG RO SYSTEMS WITHOUT PUMPS

**RX55139415****5 stage reverse osmosis system.**

Equipt with post filtration carbon cartridge (AICRO), designed to remove unpleasant taste and odors to produce cleaner, clearer, better tasting water.

Set includes:**Cartridges:**

FCPS5, FCCA, FCCBL, AICRO and TFC-75F RO membrane 75GPD.

Accessories:

faucet, feed water connector, tubing, tank, and other accessories for quick installation.

**RX65139415****6 stage reverse osmosis system.**

Equipt with post filtration carbon cartridge (AICRO), designed to remove unpleasant taste and odors to produce cleaner, clearer, better tasting water and AIMRO mineralizing cartridge, which enriches water with elements such as calcium and magnesium.

Set includes:**Cartridges:**

FCPS5, FCCA, FCCBL, AICRO, AIMRO cartridges and TFC-75F RO membrane 75 GPD.

Accessories:

faucet, feed water connector, tubing, tank, and other accessories for quick installation.

**RX75139415****7 stage reverse osmosis system with mineralizing and ionizing cartridges.**

Equipt with post filtration carbon cartridge (AICRO), designed to remove unpleasant taste and odors to produce cleaner, clearer, better tasting water, AIMRO mineralizing cartridge, which enriches water with elements such as calcium and magnesium and AIFIR2000 ionizing cartridge which helps to flush the toxins out of the organism.

Set includes:**Cartridges:**

FCPS5, FCCA, FCCBL, AICRO, AIMRO, AIFIR2000 cartridges and TFC-75F RO membrane 75 GPD.

Accessories:

faucet, feed water connector, tubing, tank, and other accessories for quick installation.

**RX55249516****5 stage reverse osmosis system.**

Equipt with post filtration carbon cartridge (AICRO), designed to remove unpleasant taste and odors to produce cleaner, clearer, better tasting water.

Set includes:**Cartridges:**

FCPS5, FCCA, FCCBL, AICRO and TFC-75F RO membrane 75 GPD.

Accessories:

double faucet, feed water connector, tubing, tank, and other accessories for quick installation.

**RX65259516****6 stage reverse osmosis system.**

Equipt with post filtration carbon cartridge (AICRO), designed to remove unpleasant taste and odors to produce cleaner, clearer, better tasting water and AIMRO mineralizing cartridge, which enriches water with elements such as calcium and magnesium.

Set includes:**Cartridges:**

FCPS5, FCCA, FCCBL, AICRO, AIMRO and TFC-75F RO membrane 75 GPD.

Accessories:

double faucet, feed water connector, tubing, tank, and other accessories for quick installation.

**RX75259516****7 stage reverse osmosis system with mineralizing and ionizing cartridges.**

Equipt with post filtration carbon cartridge (AICRO), designed to remove unpleasant taste and odors to produce cleaner, clearer, better tasting water, AIMRO mineralizing cartridge, which enriches water with elements such as calcium and magnesium and AIFIR2000 ionizing cartridge which helps to flush the toxins out of your body.

Set includes:**Cartridges:**

FCPS5, FCCA, FCCBL, AICRO, AIMRO, AIFIR2000 cartridges and TFC-75F RO membrane 75 GPD.

Accessories:

double faucet, feed water connector, tubing, tank, and other accessories.

RO SYSTEMS

AR-WPU RO SYSTEMS WITH PUMPS



RP55139715

5 stage reverse osmosis system with pump. Equipt with post filtration carbon cartridge (AICRO), designed to remove unpleasant taste and odors to produce cleaner, clearer, better tasting water. Additionally a booster pump was added, which allows to install the system in installation where water pressure is lower than 2,8 bar.

Set includes:

Cartridges:

FCPS5, FCCA, FCCBL, AICRO and TFC-75F RO membrane 75GPD.

Accessories:

pump with transformer, faucet, feed water connector, tubing, tank, and other accessories for quick installation.



RP65139715

6 stage Reverse Osmosis system with pump. Equipt with post filtration carbon cartridge (AICRO), designed to remove unpleasant taste and odors to produce cleaner, clearer, better tasting water and AIMRO mineralizing cartridge, which enriches water with elements such as calcium and magnesium. Additionally a booster pump was added, this allows to install the system in installation where water pressure is lower than 2,8 bar.

Set includes:

Cartridges:

FCPS5, FCCA, FCCBL, AICRO, AIMRO and TFC-75F RO membrane 75GPD.

Accessories:

pump with transformer, faucet, feed water connector, tubing, tank, and other accessories for quick installation.



RP75139715

7 stage Reverse Osmosis system with pump. Equipt with post filtration carbon cartridge (AICRO), designed to remove unpleasant taste and odors to produce cleaner, clearer, better tasting water and AIMRO mineralizing cartridge, which enriches water with elements such as calcium and magnesium, AIFIR2000 ionizing cartridge which helps to flush the toxins out of your body. Additionally a booster pump was added, this allows to install the system in installation where water pressure is lower than 2,8 bar.

Set includes:

Cartridges:

FCPS5, FCCA, FCCBL, AICRO, AIMRO, AIFIR2000 and TFC-75F RO membrane 75GPD.

Accessories:

pump with transformer, faucet, feed water connector, tubing, tank, and other accessories for quick installation.

AR-AQU OTHER RO SYSTEMS



RX-AFRO3-AQ

3 stage reverse osmosis system for aquarium is one of the best methods to obtain pure water. Additionally the system contains two pre-filters, which protect the membrane. Set includes: AIPRO and AICRO cartridges and TFC-75F RO membrane, feed water connector tubing, and all accessories.

Set includes:

Cartridges:

AIPRO, AICRO and TFC-75F

Accessories:

feed water connector tubing, and all accessories.

AR-CAS RO SYSTEMS IN CASES



EXCITO-OSSMO

4-stage RO water filtration system with modern design, equipt with TFC-70F-TW RO membrane and the latest TWIST type filter cartridges. System contains modern TWIST type cartridges which allows quick and easy cartridge replacement without the use of special tools.

Set includes:

Cartridges:

sediment cartridge AIPRO-1M-TW, carbon block FCCBL-S-TW, 70 GPD membrane TFC-70F-TW and post filter with minerals FCCM-TW

Accessories:

FXFCH17-C faucet, feed water connector 1/2, tubing, tank, and all accessories.

RO SYSTEMS

AR-ELITE SYSTEM RO ELITE

**ELITE7G**

Elite 7 Stage 75 GPD RO system on gray free standing bracket includes seven filtration stages without pressure gauge.

Set includes:**Cartridges:**

FCPS20-AB, FCCA, FCCBL, AICRO, AIMRO, AIFIR2000 cartridges and TFC-75F RO membrane.

Accessories:

FXFCH17-C faucet, feed water connector , tubing, tank, and all accessories.

ELITE7G-G

Elite 7 Stage 75 GPD RO system on gray free standing bracket includes seven filtration stages with pressure gauge.

Set includes:**Cartridges:**

FCPS20-AB, FCCA, FCCBL, AICRO, AIMRO, AIFIR2000 cartridges and TFC-75F RO membrane.

Accessories:

FXFCH17-C faucet, pressure gauge, feed water connector , tubing, tank, and all accessories.

ELITE7G-GP

Elite 7 Stage 75 GPD RO system on gray free standing bracket includes seven filtration stages with pump, pressure gauge.

Set includes:**Cartridges:**

FCPS20-AB, FCCA, FCCBL, AICRO, AIMRO, AIFIR2000 cartridges and TFC-75F RO membrane.

Accessories:

FXFCH17-C faucet, pressure gauge, pump, feed water connector , tubing, tank, and all accessories.

**ELITE7W**

Elite 7 Stage 75 GPD RO system on white free standing bracket includes seven filtration stages without pressure gauge.

Set includes:**Cartridges:**

FCPS20-AB, FCCA, FCCBL, AICRO, AIMRO, AIFIR2000 cartridges and TFC-75F RO membrane.

Accessories:

FXFCH17-C faucet, feed water connector 1/2, tubing, tank, and all accessories.

ELITE7W-G

Elite 7 Stage 75 GPD RO system on white free standing bracket includes seven filtration stages with pressure gauge.

Set includes:**Cartridges:**

FCPS20-AB, FCCA, FCCBL, AICRO, AIMRO, AIFIR2000 cartridges and TFC-75F RO membrane.

Accessories:

FXFCH17-C faucet, pressure gauge, feed water connector 1/2, tubing, tank, and all accessories.

ELITE7W-GP

Elite 7 Stage 75 GPD RO system on white free standing bracket includes seven filtration stages with pump, pressure gauge.

Set includes:**Cartridges:**

FCPS20-AB, FCCA, FCCBL, AICRO, AIMRO, AIFIR2000 cartridges and TFC-75F RO membrane.

Accessories:

FXFCH17-C faucet, pressure gauge, pump, feed water connector 1/2, tubing, tank, and all accessories.



AD



DWETS NEW PRODUCT



AD

DW-BB / DW-BR / DW-BG

Blue / Red / Green Bottle Filter with two cartridges DW-CO1 with total water filtration capacity 600 liters.

DW-C01 / DW-C02

Water filter cartridge for DWETS Bottle.



DW-HB

Gravity Water Filter with two bags for clean & dirty water and filter cartridge.



DW-B1

In Bottle Water Filter with water filtration capacity 300 liters.



DW-EB

Straw type emergency filter with water filtration capacity 300 liters, you can attach it to standard water bottles.

DW-C1

Gravity Water Filter cartridge.

AD

PERFORMANCE COMPARISON

| | DWETS | RO Reverse Osmosis | NF Nanofiltration | UF Ultrafiltration | CARBON BLOCK | UV Ultraviolet |
|----------------------|-------|-----------------------|----------------------|-----------------------|-----------------|-------------------|
| DISSOLVED SALTS | | 💧 | | | | |
| ENDOTOXIN | 💧 | 💧 | 💧 | 💧 | | |
| VIRUSES | 💧 | 💧 | 💧 | | | 💧 |
| BACTERIA | 💧 | 💧 | 💧 | 💧 | 💧 | 💧 |
| CYST | 💧 | 💧 | 💧 | 💧 | 💧 | 💧 |
| POLYSACCHARIDES | 💧 | 💧 | 💧 | 💧 | | |
| COLOIDS | 💧 | 💧 | 💧 | 💧 | | |
| PARTICULATES | 💧 | 💧 | 💧 | 💧 | 💧 | |
| CHEMICAL REDUCTION | 💧 | 💧 | | | 💧 | 💧 |
| TRACE PHAMACEUTICALS | 💧 | 💧 | | | 💧 | 💧 |



SALES@AQUAFILTER.COM



DISTRIBUTOR

more info



ALL AQUAFILTER IMAGES, TRADEMARKS, LOGOS AND OTHER INTELLECTUAL PROPERTY ARE THE SOLE AND EXCLUSIVE PROPERTY OF AQUAFILTER INC. AND MAY NOT BE USED WITHOUT OUR EXPRESS WRITTEN PERMISSION.



Made in EU



AQUAFILTER EUROPE

UL. ŚW. TERESY 101
91-222 ŁÓDŹ, POLAND

WWW.AQUAFILTER.COM



AQUAFILTER GERMANY



AQUAFILTER BELARUS

ADVANTA SYSTEM,
KRASNOGARDEYSKAYA
114B/5 224024 BREST,
BELARUS



Management System
ISO 9001:2015
ISO 14001:2015
www.tuv.com
ID 9105076259





MADE IN EU

AC



AH



AS AE AU AR



AA



AA

CATALOG

WWW.AQUAFILTER.COM

ACCESSORIES



TABLE OF CONTENTS

| | |
|---|----------|
| AA - ACCESSORIES | 1 |
| AA-PLBR - PLASTIC MOUNTING BRACKET | 1 |
| AA-MTBR - METAL MOUNTING BRACKET | 1 |
| AA-TUB - TUBING | 1 |
| AA-WRA - HOUSING WRENCHES | 1 |
| AA-FAUC - FAUCETS | 2 |
| AA-CLIP - MOUNTING CLIPS | 2 |
| AA-PFIT - PLASTIC CONNECTORS | 2 |
| AA-OTH - CARTRIDGE ACCESSORIES | 2 |
| AA-MFIT - METAL CONNECTORS | 3 |
| AA-PAC - PUMPS | 3 |
| AA-TRO - TANKS | 3 |
| AA-TEST - TESTERS | 3 |
| AA-JCO - JACO FITTINGS | 4 |
| AA-ORN - O-RINGS | 4 |
| AA-UV - UV LAMPS AND ACCESSORIES | 4 |
| AA-QC1 - QUICK CONNECT FITTINGS | 5 |
| AA-VAL - VALVES, REGULATORS, RESTRICTORS, DRAIN CLAMP | 6 |
| AA-GAU - PRESSURE GAUGES | 6 |
| AA-SCR - BOLTS, SCREWS, NUTS FOR MOUNTING FILTERS | 6 |
| AA-SCR - BOLTS, SCREWS, NUTS FOR MOUNTING FILTERS | 6 |
| AA-QC2 - QUICK CONNECT ECONOMY LINE | 7 |
| AA-OTH - OTHER MIX ACCESSORIES | 8 |

ACCESSORIES



AA



AA-PLBR PLASTIC MOUNTING BRACKET

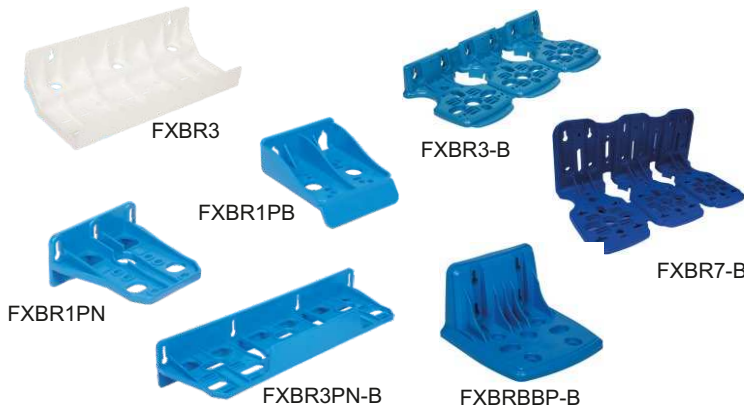

| Part no. | Housing | Section | Color |
|------------|--------------|---------|-------|
| FXBR1PB | 5" & 10" | single | blue |
| FXBR1PN | 5" & 10" | single | blue |
| FXBRBBP-B | 10" & 20" BB | single | blue |
| FXBR2 | 10" | double | white |
| FXBR2PN | 10" | double | white |
| FXBR2PN-W | 10" | double | white |
| FXBR3 | 10" | triple | white |
| FXBR3PN-B | 10" | triple | white |
| FXBR3-B | 10" | triple | white |
| FXBR7-B | 10" | triple | white |
| FXBR3PN-IW | | | white |

AA-MTBR METAL MOUNTING BRACKET



| Part no. | Housing | Section | Color | For Housings |
|----------|--------------|---------|-------|-----------------------|
| FXBRBB2 | 10" & 20" BB | double | white | |
| FXBRBB3 | 10" & 20" BB | triple | white | |
| FXBR7 | 10" & 20" | triple | steel | (not for BB housings) |
| MBK-09 | 10" | triple | metal | RO system pump |

AA-TUB TUBING



| Part no. | Thread | More Info |
|----------|--------|-------------------------------------|
| KTPE14BL | 1 / 4 | blue; 300m roll; packaging in box |
| KTPE14W | 1 / 4 | white; 300m roll; packaging in box |
| KTPE14R | 1 / 4 | red; 300m roll; packaging in box |
| KTPE14Y | 1 / 4 | yellow; 300m roll; packaging in box |
| KTPE38B | 3 / 8 | blue; 150m roll |

AA-WRA HOUSING WRENCHES



| Part no. | Clip size | For Housings |
|------------|-------------|---|
| FXWR1-BL | 10" | H10B, H10C, H10J, H10A, H10K, H105 |
| FXWR2 | 10" | H10I |
| FXWR3 | 5" and 10" | for 3-part filters (old type filter housing) |
| FXWR3-BL | 5" and 10" | for 3-part filters (new type filter housing made in EU) |
| FXWR | 10" | RO YT-25W (Hm20) |
| FXWR1BB-BL | 10" and 20" | BB, HB1B, HB1D, HB1C, HB2B, HB2D, HB2C |
| FXWR-L | 10" | for 2.5 x 20" filter housing |
| FXWR1BB | 10" and 20" | FH10B64, FH20B64, FHBC10B1, FHBC20B1 |

AA-FAUCET FAUCETS



| Part no. | Section | Material |
|-------------|--------------|---|
| FXFCH4 | double brass | chrome-plated, ceramic valve |
| FXFCH5 | single brass | chrome-plated, ceramic valve |
| FXFCH16-C | double brass | chrome-plated (new style) |
| FXFCH17-C | single brass | chrome-plated (new style) |
| FXFCH13-3-M | three-way | matt (kitchen) for cold/hot & filtered water |
| FXFCH15-3-C | three-way | chrome-plated (kitchen) for cold/hot & filtered water |
| FXFCH13-4-M | four-way | matt (kitchen) for potable cold/hot & filtered water |
| FXFCH14-4-M | four-way | matt (kitchen) for potable cold/hot & filtered water |

AA-CLIP MOUNTING CLIPS



| Part no. | Clip size | More Info |
|-----------|-----------------|----------------------------------|
| KF101 | 2" | single white plastic 2" |
| C2500W | 2 1/2" | single white plastic clip 2 1/2" |
| C3000W | 3" | single white plastic clip 3" |
| DC-2000W. | 2" x 2" | double white plastic clip |
| DC-2500W | 2" x 2 1/2" | double white plastic clip |
| DC-3000W | 2 1/2" x 2 1/2" | triple white plastic clip |

AA-PFIT PLASTIC CONNECTORS



| Part no. | Thread | Connector |
|-----------|-----------------------------------|-------------------------|
| FXCG1 | 1" MIP x 1" MIP (plastic BSP) | filter housing |
| FXCG34 | 3/4" MIP x 3/4" MIP (plastic BSP) | filter housing |
| FXCG12 | 1/2" MIP x 1/2" MIP (plastic BSP) | filter housing |
| KF1415 | 1/4" MIP x 1/4" MIP (plastic NPT) | filter housing |
| FXCG1-OR | 1" MIP BSP x 1" MIP BSP | coupling with 2 O-rings |
| FXCG34-OR | 3/4" MIP BSP x 3/4" MIP BSP | coupling with 2 O-rings |
| FXCG12-OR | 1/2" MIP BSP x 1/2" MIP BSP | coupling with 2 O-rings |
| KF1415-OR | 1/4" MIP NPT x 1/4" MIP NPT | coupling with 2 O-rings |
| FX134 | 1" MIP x 3/4" FIP (plastic NPT) | reducing Bushing |
| FX3412 | 3/4" MIP x 1/2" FIP (plastic NPT) | reducing Bushing |
| FX3438 | 3/4" MIP x 3/8" FIP (plastic NPT) | reducing Bushing |
| FX3414 | 3/4" MIP x 1/4" FIP (plastic NPT) | reducing Bushing |
| FX1214 | 1/2" MIP x 1/4" FIP (plastic NPT) | reducing Bushing |
| FT06-P | 1/2" MIP x 1/2" FIP x 1/4" FIP | plastic coupling |

AA-OTH CARTRIDGE ACCESSORIES



| Part no. | Thread | More Info |
|-------------------|--------|--|
| CC25 | 2 1/2" | connector for 10" and 20" cartridges |
| CC45 | 4 1/2" | connector for 10" and 20" cartridges in Big Blue |
| NI-212-CENT-GR-AB | 2 1/2" | bacteriostatic centering disc |
| NI-412-CENT-GR-AB | 4 1/2" | bacteriostatic centering disc for Big Blue |

ACCESSORIES

AA-MFIT METAL CONNECTORS



| Part no. | Thread | More Info |
|---------------|---|------------------------------------|
| FT03 | 3/8" M x 3/8" M x 1/4" F | brass chrome plated BSP coupling |
| FT06 | 1/2" M x 1/2" F x 1/4" F | brass chrome plated BSP coupling |
| FT04 | 1/2" M x 1/2" F x 1/2" F | t-style brass fitting chrome BSP |
| FT07 | 3/4" M x 3/4" F x 1/4" F | brass chrome plated BSP coupling |
| FT06-14QCV | 1/2" M x 1/2" F with valve for tube 1/4" QC | brass chrome plated BSP coupling |
| FT06-38QCV | 3/8" M x 3.8" F with valve for tube 1/4" QC | brass chrome plated BSP coupling |
| FXFTP | male type threading (M22x1 x M24x1) | chrome plated brass faucet adapter |
| FXFVP-2 | M22x1 female - 1/4" tube | chrome plated brass faucet adapter |
| SEWBV1414 | 1/4" NPT x 1/4" tube hose connection | brass, nickel plated ball valve |
| ADV-REG-CR-AQ | 1/2" male x 1/2" female x 1/4" tube | pres.reg.with valve SEWBV1414 |
| ADV-REG-AQ | 1/4" quick connect x 1/4" tube | pres.reg.with valve SEWBV1414 |

AA-PAC PUMPS



| Part no. | Info |
|---------------|--|
| AFXPOMP | RO pump mount on steel bracket |
| AFXPOMP-4 | RO pump for mount in plastic case |
| M1207515 | diaphragm RO pump for 75GPD systems |
| M120501-T17-C | transformer for pump – 220V/24V, 1.7A with type C plug |
| M120501-T17-G | transformer for pump – 220V/24V, 1.7A with type G plug |
| M120501-T50 | transformer for large flow pump – 220V/24V 5.0A |
| AQ-HP1000-B | high pressure switch (black) 1/4" QC |
| AJ-HP1000-B | high pressure switch (black)- Jaco 1/4" Tube |
| AQ-LP1000-B | low pressure switch (black) 1/4" QC |
| AT-LP1000-B | low pressure switch - 1/4" NPT |
| AT-SV-1000 | solenoid valve 24V DC-230mA (2 x 1/4" NPT) |

AA-TRO TANKS



| Part no. | Info |
|------------|--|
| PRO3200P-G | White plastic 3.2 gallon water tank (12 liters) for RO system. |
| PRO4000W | White plastic 4.0 gallon water tank (15 liters) for RO system. |

AA-TEST TESTERS



| Part no. | Info |
|----------|---|
| FXT-3-AQ | Seven water quality testing set for types of impurities (two of each tests) |
| PH600 | pH meter with "Hold" function. |
| RT750 | quality control TDS tester equipped with setting gauge |
| TDS-3 | professional TDS meter |
| TDS81 | flow control TDS monitor install to 1/4" Quick Connector |
| PDEZYN2 | single use disinfection set |
| ORP-1 | ORP meter |

AA-JCO JACO TYPE FITTINGS



AJ-1066



AJ-2044



AJ-4044



AJ-7044



AJ-0104

| Part No. | Thread |
|----------|--|
| AJ-1044 | 1/4" Tube O.D. 1/4" NPT - Jaco, male connector |
| AJ-1046 | 1/4" Tube O.D. 3/8" NPT - Jaco, male connector |
| AJ-1064 | 3/8" Tube O.D. 1/4" NPT - Jaco, male connector |
| AJ-1066 | 3/8" Tube O.D. 3/8" NPT - Jaco, male connector |
| AJ-1544 | 1/4"-1/4" Tube O.D. - Jaco, union connector |
| AJ-1564 | 3/8"-1/4" Tube O.D. - Jaco, reducing union |
| AJ-2044 | 1/4"-1/4" Tube O.D. - Jaco, bulkhead union |
| AJ-2066 | 3/8"-3/8" Tube O.D. - Jaco, bulkhead union |
| AJ-2542 | 1/4" Tube O.D. 1/8" NPTF - Jaco, female connector |
| AJ-2544 | 1/4" Tube O.D. 1/4" NPTF - Jaco, female connector |
| AJ-4042 | 1/4" Tube O.D. 1/8" NPT - Jaco, male elbow |
| AJ-4044 | 1/4" Tube O.D. 1/4" NPT - Jaco, male elbow |
| AJ-4046 | 1/4" Tube O.D. 3/8" NPT - Jaco, male elbow |
| AJ-4064 | 3/8" Tube O.D. 1/4" NPT - Jaco, male elbow |
| AJ-4066 | 3/8" Tube O.D. 3/8" NPT - Jaco, male elbow |
| AJ-4544 | 1/4" Tube O.D. 1/4" NPT - Jaco, female elbow |
| AJ-6044 | 1/4"-1/4" Tube O.D. 1/4" NPT - Jaco, male branch tee |
| AJ-6068 | 3/8"-3/8" Tube O.D. 1/2" NPT - Jaco, male branch tee |
| AJ-7044 | 1/4"-1/4"-1/4" Tube O.D. - Jaco, union tees |
| AJ-7066 | 3/8"-3/8"-3/8" Tube O.D. - Jaco, union tees |
| AJ-7544 | 1/4"-1/4" Tube O.D. 1/4" NPT - Jaco, male run tee |
| AJ-7568 | 3/8"-3/8" Tube O.D. 1/2" NPT - Jaco, male run tee |
| AJ-0104 | 1/4" Tube O.D., compression nut |
| AJ-0308 | 3/8" Tube O.D., compression nut |
| INS14 | 1/4", Jaco insert for tubing |

AA-ORN O-RINGS



OR-N-110X255



OR-N-880X40



OR-H10-1

| Part no. | Info |
|--------------|--|
| OR-N-915X40 | o-ring made of NBR for H10I |
| OR-N-630X40 | upper and bottom O-ring for RO membrane housing YT-25W |
| OR-N-925X40 | o-ring for RO membrane housing YT-3 (Hm35) |
| OR-N-1524X57 | o-ring for new type Big Blue 10" and 20" blue x blue |
| OR-N-110X255 | o-ring for pressure relief valve: H10C, HB1B, HB1D, HB2B, HB2D |
| OR-N-1080X35 | o-ring for (H20A,H104,H20H) |
| OR-N-880X40 | top O-ring for filter housing: H10A, H10Bx, H10C, H10D, H10K, H105 |
| OR-N-900X35 | top O-ring for filter housing: H10A, H10B, H10C, H10D, H10K, H105 |
| OR-H10-1 | set bottom top O-rings for filter housings |
| OR-N-890X30 | o-ring for 3 pc filter housing H05A, H05A-AB, H10Gx |
| OR-N-890X35 | o-ring for 3 pc filter housing H010G, H101 (old type) |
| OR-N-940X35 | bottom O-ring for the housing from EG14-2 type |











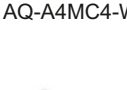



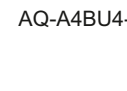

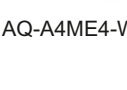

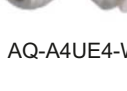

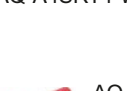
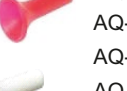

AA-UV UV LAMPS AND ACCESORIES



| Part no. | Info |
|----------|--------------------------------------|
| P4-GT | UV light bulb for FUV-P4W_K UV lamp. |

ACCESSORIES

AA-QC1 Quick Connect Fittings

| | Part no. | Thread |
|---|-------------|--|
|  | AQ-A4MC2-W | 1/4" tube O.D. 1/8" NPT - QC male connector |
|  | AQ-A4MC4-W | 1/4" tube O.D. 1/4" NPT - QC male connector |
|  | AQ-A4MC5-W | 1/4" tube O.D. 3/8" NPT - QC male connector |
|  | AQ-A5MC4-W | 3/8" tube O.D. 1/4" NPT - QC male connector |
|  | AQ-A5MC5-W | 3/8" tube O.D. 3/8" NPT - QC male connector |
|  | AQ-A5MC6-W | 3/8" tube O.D. 1/2" NPT - QC male connector |
|  | AQ-A4UC4-W | 1/4"-1/4" tube O.D. - QC union connector |
|  | AQ-A5UC4-W | 3/8"-1/4" tube O.D. - QC union connector |
|  | AQ-A5UC5-W | 3/8"-3/8" tube O.D. - QC union connector |
|  | AQ-A4FA4-W | 1/4" tube O.D. 1/4" NPTF - QC female adapter |
|  | AQ-A4FA12 | 1/4" tube O.D. 1/2" BSP female - QC female adapter |
|  | AQ-A4FA716 | 1/4" tube O.D. 7/16" female - QC female adapter |
|  | AQ-A5FA716 | 3/8" tube O.D. 7/16" female - QC female adapter |
|  | AQ-A4SA4-W | 1/4" stem x 1/4" NPT - QC stem adapter |
|  | AQ-A4SA5-W | 1/4" stem x 3/8" NPT - QC stem adapter |
|  | AQ-A5SA4-W | 3/8" stem x 1/4" NPT - QC stem adapter |
|  | AQ-A5SA5-W | 3/8" stem x 3/8" NPT - QC stem adapter |
|  | AQ-A4BU4-W | 1/4"-1/4" tube O.D. - QC bulkhead union |
|  | AQ-A4BU5-W | 1/4"-3/8" tube O.D. - QC bulkhead union |
|  | AQ-A5BU5-W | 3/8"-3/8" tube O.D. - QC bulkhead union |
| | AQ-A4ME2-W | 1/4" tube O.D. 1/8" NPT - QC male elbow |
| | AQ-A4ME4-W | 1/4" tube O.D. 1/4" NPT - QC male elbow |
| | AQ-A4ME5-W | 1/4" tube O.D. 3/8" NPT - QC male elbow |
| | AQ-A5ME4-W | 3/8" tube O.D. 1/4" NPT - QC male elbow |
| | AQ-A5ME5-W | 3/8" tube O.D. 3/8" NPT - QC male elbow |
| | AQ-A4UE4-W | 1/4"-1/4" tube O.D. - QC union & reducing elbow |
| | AQ-A5UE4-W | 3/8"-1/4" tube O.D. - QC union & reducing elbow |
| | AQ-A5UE5-W | 3/8"-3/8" tube O.D. - QC union & reducing elbow |
| | AQ-A4SE4-W | 1/4" tube O.D. 1/4" stem - QC stem elbow |
| | AQ-A4SE5-W | 1/4" tube O.D. 3/8" stem - QC stem elbow |
| | AQ-A5SE4-W | 3/8" tube O.D. 1/4" stem - QC stem elbow |
| | AQ-A5SE5-W | 3/8" tube O.D. 3/8" stem - QC stem elbow |
| | AQ-A4MBT4-W | 1/4"-1/4" tube O.D. 1/4" NPT - QC male branch tee |
| | AQ-A4MBT5-W | 3/8"-3/8" tube O.D. 3/8" NPT - QC male branch tee |
| | AQ-A4TU4-W | 1/4"-1/4"-1/4" tube O.D. - QC union tee |
| | AQ-A4TUR5-W | 1/4"-3/8"-1/4" tube O.D. - QC union tee |
| | AQ-A5TUR4-W | 3/8"-1/4"-3/8" tube O.D. - QC union tee |
| | AQ-A5TU5-W | 3/8"-3/8"-3/8" tube O.D. - QC union tee |
| | AQ-A4MT4-W | 1/4"-1/4" tube O.D. 1/4" NPT - QC male run tee |
| | AQ-A5MT4-W | 3/8"-1/4" tube O.D. 1/4" NPT - QC male run tee |
| | AQ-A4TR4-W | 1/4"-1/4" tube O.D. 1/4" Stem - QC stem branch tee |
| | AQ-A5TR5-W | 3/8"-3/8" tube O.D. 3/8" Stem - QC stem branch tee |
| | AQ-A4SRT4-W | 1/4"-1/4" tube O.D. 1/4" Stem - QC stem run tee |
| | AQ-A5SRT5-W | 3/8"-3/8" tube O.D. 3/8" Stem - QC stem run tee |
| | AQ-A4TWD4-W | 1/4"-1/4"-1/4" tube O.D. - QC two way divider |
| | AQ-A5TWD5-W | 3/8"-3/8"-3/8" tube O.D. - QC two way divider |
|  | AQ-PL2-B | 1/4" - blue color - locking clip |
|  | AQ-PL2-G | 1/4" - black color - locking clip |
|  | AQ-PL2-R | 1/4" - red color - locking clip |
|  | AQ-PL2-Y | 1/4" - yellow color - locking clip |
|  | AQ-PL2-W | 1/4" - white color - locking clip |
|  | AQCWW-W | universal wrench for quick connect system |
| | AQ-PL2-B | 1/4" OD. - blue color plug |
| | AQ-PL2-G | 1/4" OD. - black color plug |
| | AQ-PL2-R | 1/4" OD. - red color plug |
| | AQ-PL2-Y | 1/4" OD. - yellow color plug |
| | AQ-PL2-W | 1/4" OD. - white color plug |
| | AQ-A4W | 1/4" - collets |
| | AQ-A5W | 3/8" - collets |

AA-VAL VALVES, PRESSURE REGULATORS, FLOW RESTRICTORS



| Part no. | Thread |
|-----------------|--|
| AJ-4042-CV | male elbow w/check valve 1/4" Tube O.D. x 1/8" NPT - Jaco |
| AQ-A4ME2-CV-W | elbow white 1/8" NPT x 1/4" tube QC with check valve |
| AQ-A4UC4-CV-W | white coupling 1/4" tube x 1/4" tube with check valve |
| CV14 | stainless steel flow check valve 1/8" x 1/8" threaded connection |
| CV1418 | white plastic flow check valve 1/8"M x 1/4"M. |
| AT-BV250W | white ball valve 1/4" FIP (NPT) x 1/4" FIP (NPT) threaded connection |
| AQ-SEWBV1414-PP | plastic ball valve 1/4" MIP (NPT) x 1/4" QC |
| AQ-BV9014 | white RO tank ball valve 1/4" FIP (NPT) x 1/4" QC |
| AQ-BV250W | white ball valve 2 x 1/4"F QC |
| AJ-BV9014 | white RO tank ball valve 1/4"FIP (NPT) x 1/4" JACO |
| FR-FLUSH | RO flush kit for membranes |
| AJ-S-3000W | white four way valve 4 x 1/4" Tube O.D. - Jaco |
| AQ-S-3000W | white four way valve 4 x 1/4" QC |
| AQ-FR-300 | flow Restrictor - 300cc - QC |
| AQ-FR-420 | flow Restrictor - 420cc - QC |
| AQ-FR-550 | flow Restrictor - 550cc - QC |
| AT-FR-300 | flow Restrictor - 300cc - Female 1/4" NPT |
| AT-FR-420 | flow Restrictor - 420cc - Female 1/4" NPT |
| AT-FR-800 | flow Restrictor - 800cc - Female 1/4" NPT |
| AT-FR-1200 | flow Restrictor - 1200cc - Female 1/4" NPT |
| AJ-FR-300 | flow Restrictor - 300cc - Jaco |
| AJ-FR-420 | flow Restrictor - 420cc - Jaco |
| AJ-FR-550 | flow Restrictor - 550cc - Jaco |
| AT-SC500B14 | drain clamp Female 1/4" NPT |
| AJ-SC500B14 | drain Saddle - 1/4" OD - Jaco |
| AQ-SC500B14 | drain Saddle - 1/4" OD - QC |
| F10SV-2 | brass ball valve 3/8" MIP (BSP) x 3/8" FIP (BSP) |
| AIMIAO2 | mechanical leak prevention sensor 1/4" tube Male |
| PLV-0104-50 | pressure limiting valve and water hammer - 1/4" for 3.45 bar |
| PLV-0104-80 | pressure limiting valve and water hammer - 1/4" for 5.50 bar |

AA-GAU PRESSURE GAUGES, CONNECTORS



| Part no. | Info |
|-----------|---|
| KCGA-1 | pressure gauge w. 0-10 bar range, Thread size 1/4" NPT, Dial diameter 52 mm |
| KCGA-2 | pressure gauge w. 0-16 bar range, Thread size 1/4" NPT, Dial diameter 50 mm |
| KCGA-3 | pressure gauge liquid-filled 0-10 bar Thread 1/4" NPT, Dial diameter 63 mm |
| KCGA-4 | pressure gauge liquid-filled 0-10 bar Thread 1/4" NPT, Dial diameter 46 mm |
| KCGA-1-E2 | component for KCGA-1 (extension) 1/8" MIP (BSP) x 1/4" FIP (NPT) |
| PLV-KCGA | pressure reducing valve 3/4" FIP x 3/4" FIP with pressure gauge |

AA-SCR BOLTS, SCREWS, NUTS FOR MOUNTING FILTERS



| Part no. | Info |
|-----------------|---|
| QSX-SN-L16-D42 | screws nickel plated |
| QSX-SN-L16-D48 | screws nickel plated |
| QSX-SN-L20-D42 | screws for housings nickel plated |
| QSX-SN-L20-D48 | screws for housings nickel plated |
| QS6-SN-L35-D80 | screws for Big Blue heads nickel plated |
| QSX-SS-L16-D42 | screw for Pressure Relief Valve (old type) stainless steel |
| AQF-PRV-5-SCREW | screw for Pressure Relief Valve stainless steel |
| AQF-PRV-3-SCREW | brass screw for Pressure Relief Valve (new type) filter housings series |

ACCESSORIES

AA-QC2 Quick Connect Economy Line



Elbow Union

| Part No. | Tube O.D. | Tube O.D. |
|------------|-----------|-----------|
| AQF-PV0202 | 1 / 4" | 1 / 4" |
| AQF-PV0303 | 3 / 8" | 3 / 8" |
| AQF-PV0203 | 1 / 4" | 3 / 8" |



Male Elbow

| Part No. | Tube O.D. | Thread |
|------------|-----------|--------|
| AQF-PL0201 | 1 / 4" | 1 / 8" |
| AQF-PL0202 | 1 / 4" | 1 / 4" |
| AQF-PL0203 | 1 / 4" | 3 / 8" |
| AQF-PL0204 | 1 / 4" | 1 / 2" |
| AQF-PL0301 | 3 / 8" | 1 / 8" |
| AQF-PL0302 | 3 / 8" | 1 / 4" |
| AQF-PL0303 | 3 / 8" | 3 / 8" |
| AQF-PL0304 | 3 / 8" | 1 / 2" |



Female Elbow

| Part No. | Tube O.D. | Thread |
|-------------|-----------|--------|
| AQF-PLF0204 | 1 / 4" | 1 / 2" |
| AQF-PLF0304 | 3 / 8" | 1 / 2" |



Elbow Stem Union

| Part No. | Tube O.D. | Stem O.D. |
|-------------|-----------|-----------|
| AQF-PLT0202 | 1 / 4" | 1 / 4" |
| AQF-PLT0203 | 1 / 4" | 3 / 8" |
| AQF-PLT0303 | 3 / 8" | 3 / 8" |
| AQF-PLT0302 | 3 / 8" | 1 / 4" |



Elbow Stem Union

| Part No. | Tube O.D. | Stem O.D. |
|---------------|-----------|-----------|
| AQF-PLT0202-L | 1 / 4" | 1 / 4" |



Union Connector

| Part No. | Tube O.D. | Tube O.D. |
|------------|-----------|-----------|
| AQF-PU0202 | 1 / 4" | 1 / 4" |
| AQF-PU0303 | 3 / 8" | 3 / 8" |
| AQF-PU0203 | 1 / 4" | 3 / 8" |



Male Connector

| Part No. | Tube O.D. | Thread |
|------------|-----------|--------|
| AQF-PC0201 | 1 / 4" | 1 / 8" |
| AQF-PC0202 | 1 / 4" | 1 / 4" |
| AQF-PC0203 | 1 / 4" | 3 / 8" |
| AQF-PC0204 | 1 / 4" | 1 / 2" |
| AQF-PC0301 | 3 / 8" | 1 / 8" |
| AQF-PC0302 | 3 / 8" | 1 / 4" |
| AQF-PC0303 | 3 / 8" | 3 / 8" |
| AQF-PC0304 | 3 / 8" | 1 / 2" |



Female Adapter

| Part No. | Tube O.D. | Thread |
|-------------|-----------|--------|
| AQF-PCF0201 | 1 / 4" | 1 / 8" |
| AQF-PCF0202 | 1 / 4" | 1 / 4" |
| AQF-PCF0203 | 1 / 4" | 3 / 8" |
| AQF-PCF0204 | 1 / 4" | 1 / 2" |
| AQF-PCF0301 | 3 / 8" | 1 / 8" |
| AQF-PCF0302 | 3 / 8" | 1 / 4" |
| AQF-PCF0303 | 3 / 8" | 3 / 8" |
| AQF-PCF0304 | 3 / 8" | 1 / 2" |



Union Tee

| Part No. | Tube O.D. | Tube O.D. | Tube O.D. |
|--------------|-----------|-----------|-----------|
| AQF-PE020202 | 1 / 4" | 1 / 4" | 1 / 4" |
| AQF-PE030303 | 3 / 8" | 3 / 8" | 3 / 8" |
| AQF-PE020302 | 1 / 4" | 3 / 8" | 1 / 4" |
| AQF-PE020303 | 1 / 4" | 3 / 8" | 3 / 8" |
| AQF-PE020203 | 1 / 4" | 1 / 4" | 3 / 8" |
| AQF-PE030203 | 3 / 8" | 1 / 4" | 3 / 8" |



Main Stem Tee

| Part No. | Tube O.D. | Steam O.D. | Tube O.D. |
|---------------|-----------|------------|-----------|
| AQF-PBT020202 | 1 / 4" | 1 / 4" | 1 / 4" |
| AQF-PBT030303 | 3 / 8" | 3 / 8" | 3 / 8" |



Male Branch Tee

| Part No. | Tube O.D. | Thread | Tube O.D. |
|--------------|-----------|--------|-----------|
| AQF-PB020202 | 1 / 4" | 1 / 4" | 1 / 4" |
| AQF-PB030303 | 3 / 8" | 3 / 8" | 3 / 8" |
| AQF-PB020203 | 1 / 4" | 3 / 8" | 1 / 4" |
| AQF-PB020302 | 1 / 4" | 3 / 8" | 3 / 8" |
| AQF-PB020303 | 3 / 8" | 1 / 4" | 3 / 8" |



Male Tee Union

| Part No. | Tube O.D. | Tube O.D. | Thread |
|--------------|-----------|-----------|--------|
| AQF-PD020202 | 1 / 4" | 1 / 4" | 1 / 4" |
| AQF-PD020203 | 1 / 4" | 1 / 4" | 3 / 8" |
| AQF-PD020302 | 1 / 4" | 3 / 8" | 1 / 4" |
| AQF-PD020303 | 1 / 4" | 3 / 8" | 3 / 8" |
| AQF-PD030302 | 3 / 8" | 3 / 8" | 1 / 4" |



Stem T Union

| Part No. | Tube O.D. | Tube O.D. | Stem O.D. |
|--------------|-----------|-----------|-----------|
| AQF-PD020202 | 1 / 4" | 1 / 4" | 1 / 4" |



Two Way Divider

| Part No. | Tube O.D. | Tube O.D. | Tube O.D. |
|--------------|-----------|-----------|-----------|
| AQF-PY020202 | 1 / 4" | 1 / 4" | 1 / 4" |
| AQF-PY030303 | 3 / 8" | 3 / 8" | 3 / 8" |
| AQF-PY030202 | 3 / 8" | 1 / 4" | 1 / 4" |



Bulkhead

| Part No. | Tube O.D. | Tube O.D. | Diameter |
|-------------|-----------|-----------|----------|
| AQF-PUM0202 | 1 / 4" | 1 / 4" | φ15.0 mm |
| AQF-PUM0303 | 3 / 8" | 3 / 8" | φ20.0 mm |



Bulkhead Union

| Part No. | Tube O.D. | Tube O.D. |
|------------|-----------|-----------|
| AQF-PM0202 | 1 / 4" | 1 / 4" |
| AQF-PM0303 | 3 / 8" | 3 / 8" |
| AQF-PM0203 | 1 / 4" | 3 / 8" |



Elbow Check Valve

| Part No. | Tube O.D. | Thread |
|--------------|-----------|--------|
| AQF-PLNZ0201 | 1 / 4" | 1 / 8" |
| AQF-PLNZ0202 | 1 / 4" | 1 / 4" |



Check Elbow Valves

| Part No. | Tube O.D. | Tube O.D. |
|--------------|-----------|-----------|
| AQF-PVNZ0202 | 1 / 4" | 1 / 4" |



Check Valves

| Part No. | Tube O.D. | Tube O.D. |
|--------------|-----------|-----------|
| AQF-PUNZ0202 | 1 / 4" | 1 / 4" |

ACCESSORIES



Flow Restrictor

| Part No. | Tube O.D. | Tube O.D. |
|--------------|-----------|-----------|
| AQF-FR300CC | 1 / 4 | 1 / 4 |
| AQF-FR450CC | 1 / 4 | 1 / 4 |
| AQF-FR1500CC | 1 / 4 | 1 / 4 |



High Pressure Switch

| Part No. | Tube O.D. | Tube O.D. |
|-----------|-----------|-----------|
| AQF-HP001 | 1 / 4 | 1 / 4 |



Mixing Valve
(allows water quality adjustment)

| Part No. | Tube O.D. | Tube O.D. |
|------------|-----------|-----------|
| AQF-NSF-02 | 1 / 4 | 1 / 4 |



Low Pressure Switch

| Part No. | Tube O.D. |
|-----------|-----------|
| AQF-LP001 | 1 / 4 |



Auto Shutoff Valve

| Part No. | Tube O.D. _(a,b) | Tube O.D. _(c,d) |
|------------|----------------------------|----------------------------|
| AQF-SMF-02 | 1 / 4 | 1 / 4 |



Suction Head Tube Filter Strainer

| Part No. | Tube O.D. |
|------------|-----------|
| AQF-ZXT-02 | 1 / 4" |
| AQF-ZXT-03 | 3 / 8" |



Male Hand Valve

| Part No. | Tube O.D. | Thread |
|-------------|-----------|--------|
| AQF-PAW0202 | 1 / 4 | 1 / 4 |
| AQF-PAW0303 | 3 / 8 | 3 / 8 |



Pressure Reducer

| Part No. | Tube O.D. | Tube O.D. |
|------------|-----------|-----------|
| AQF-JYF-02 | 1 / 4 | 1 / 4 |



Hand Valve Union Connector

| Part No. | Tube O.D. | Tube O.D. |
|------------|-----------|-----------|
| AQF-PA0202 | 1 / 4 | 1 / 4 |
| AQF-PA0303 | 3 / 8 | 3 / 8 |



Nylon Three Way

| Part No. | Stem O.D. | Thread | Thread |
|-----------|-----------|--------|--------|
| AQF-NT001 | 1 / 4 | 1 / 2 | 1 / 2 |



Three Way Hand Valve

| Part No. | Tube O.D. | Thread | Thread |
|------------|-----------|--------|--------|
| AQF-PAST02 | 1 / 4 | 1 / 2 | 1 / 2 |
| AQF-PAST03 | 3 / 8 | 1 / 2 | 1 / 2 |



Hand Valve Female Adapter

| Part No. | Tube O.D. | Thread |
|-------------|-----------|--------|
| AQF-PAN0202 | 1 / 4 | 1 / 4 |
| AQF-PAN0203 | 1 / 4 | 3 / 8 |
| AQF-PAN0303 | 3 / 8 | 3 / 8 |
| AQF-PAN0302 | 3 / 8 | 1 / 4 |



Three Way Hand Valve

| Part No. | Tube O.D. | Thread | Thread |
|--------------|-----------|--------|--------|
| AQF-PAST02-1 | 1 / 4 | 1 / 2 | 1 / 2 |
| AQF-PAST03-1 | 3 / 8 | 1 / 2 | 1 / 2 |

AA-OTH Other Mix Accessories



Flexible Corrugated Stainless Steel Water Connectors

| Part no. | Info |
|-------------|---|
| HE1X25W3M3F | Flexible tubing white 25 cm 3/4" MIP (BSP) x 3/4" FIP (BSP) |
| HE1X50W3M3F | Flexible tubing white 50 cm 3/4" MIP (BSP) x 3/4" FIP (BSP) |
| HE1X25W1M1F | Flexible tubing white 25 cm 1" MIP (BSP) x 1" FIP (BSP) |
| HE1X50W1M1F | Flexible tubing white 50 cm 1" MIP (BSP) x 1" FIP (BSP) |
| HE1X25B3M3F | Flexible tubing blue 25 cm 3/4" MIP (BSP) x 3/4" FIP (BSP) |
| HE1X50B3M3F | Flexible tubing blue 50 cm 3/4" MIP (BSP) x 3/4" FIP (BSP) |
| HE1X25B1M1F | Flexible tubing blue 25 cm 1" MIP (BSP) x 1" FIP (BSP) |
| HE1X50B1M1F | Flexible tubing blue 50 cm 1" MIP (BSP) x 1" FIP (BSP) |



Brass 4-way by-pass valve

| Part No. | Thread |
|------------|---------|
| A-VAL4X1-1 | 1" x 1" |

NOTE

- Do not use with water that is microbiologically unsafe or of unknown quality without adequate disinfection before or after the system.
- Water filtration systems can help reduce the presence of contaminants. In addition, some water filtration systems can help reduce the presence of microorganisms or other contaminants with potential health effects.
- We strongly recommend regularly scheduled maintenance and replacement of the filter cartridge in order for the product to perform properly.
- Replace the filter cartridge at least every 6 or 12 months (depending on water quality and water consumption)

LIMITED WARRANTY: Manufacturer warrants that this product is free from defects in materials and workmanship. This warranty, together with any and all warranties implied by law, shall be limited to a period of two (2) years from the date of original purchase. This limited warranty does not apply to failures that result from abuse, misuse, alteration or failure to properly comply with installation, or cartridge change instructions.

We strongly recommend adding to all point of use and point of entry a Pressure Limiting Valve or Pressure regulator to guard against unwanted extreme water pressure events such as, but not limited to, pressure increases, surges, and water hammer which could occur in the water pipes. Not having one installed could mean that if you ever did have to claim damage caused by a burst water filter system, the claim will be denied.

All Aquafilter images, trademarks, logos, and other intellectual property are the sole and exclusive property of Aquafilter Europe and may not be used without our express written consent.



SALES@AQUAFILTER.COM



DISTRIBUTOR

more info



ALL AQUAFILTER IMAGES, TRADEMARKS, LOGOS AND OTHER INTELLECTUAL PROPERTY ARE THE SOLE AND EXCLUSIVE PROPERTY OF AQUAFILTER INC. AND MAY NOT BE USED WITHOUT OUR EXPRESS WRITTEN PERMISSION.



Made in EU



AQUAFILTER EUROPE

UL. ŚW. TERESY 101
91-222 ŁÓDŹ, POLAND

WWW.AQUAFILTER.COM



AQUAFILTER GERMANY



AQUAFILTER BELARUS

ADVANTA SYSTEM,
KRASNOGARDEYSKAYA
114B/5 224024 BREST,
BELARUS



Management System
ISO 9001:2015
ISO 14001:2015
www.tuv.com
ID 9105076259

